

SEMiX453GB12E4I33p



SEMiX® 3p shunt

Trench IGBT Modules

SEMiX453GB12E4I33p

Features*

- Homogeneous Si
- Trench = Trenchgate technology
- $V_{CE(sat)}$ with positive temperature coefficient
- High short circuit capability
- Press-fit pins as auxiliary contacts
- Current sensing shunt resistor
- UL recognized, file no. E63532

Typical Applications

- AC inverter drives
- UPS
- Renewable energy systems

Remarks

- Product reliability results are valid for $T_j=150^\circ\text{C}$
- V_{isol} between temperature sensor and power section is only 2500V
- For storage and case temperature with TIM see document "TP(*) SEMiX 3p"

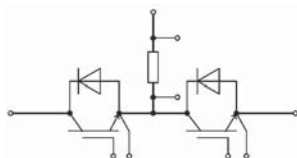

GB + shunt

Absolute Maximum Ratings				
Symbol	Conditions	Values	Unit	
IGBT				
V_{CES}	$T_j = 25^\circ\text{C}$	1200	V	
I_C	$T_j = 175^\circ\text{C}$	$T_c = 25^\circ\text{C}$	678	A
		$T_c = 80^\circ\text{C}$	521	A
I_{Cnom}		450	A	
I_{CRM}	$I_{CRM} = 3 \times I_{Cnom}$	1350	A	
V_{GES}		-20 ... 20	V	
t_{psc}	$V_{CC} = 800\text{ V}$ $V_{GE} \leq 15\text{ V}$ $V_{CES} \leq 1200\text{ V}$	$T_j = 150^\circ\text{C}$	10	μs
T_j		-40 ... 175	$^\circ\text{C}$	
Inverse diode				
V_{RRM}	$T_j = 25^\circ\text{C}$	1200	V	
I_F	$T_j = 175^\circ\text{C}$	$T_c = 25^\circ\text{C}$	578	A
		$T_c = 80^\circ\text{C}$	433	A
I_{Fnom}		450	A	
I_{FRM}	$I_{FRM} = 2 \times I_{Fnom}$	900	A	
I_{FSM}	$t_p = 10\text{ ms, sin } 180^\circ, T_j = 25^\circ\text{C}$	2430	A	
T_j		-40 ... 175	$^\circ\text{C}$	
Module				
$I_{t(RMS)}$	$T_c = 80^\circ\text{C}$	600	A	
T_{stg}	module without TIM	-40 ... 125	$^\circ\text{C}$	
V_{isol}	AC sinus 50Hz, $t = 1\text{ min}$	4000	V	

Characteristics					
Symbol	Conditions	min.	typ.	max.	Unit
IGBT					
$V_{CE(sat)}$	$I_C = 450\text{ A}$ $V_{GE} = 15\text{ V}$ chiplevel	$T_j = 25^\circ\text{C}$	1.80	2.05	V
		$T_j = 150^\circ\text{C}$	2.19	2.40	V
V_{CE0}	chiplevel	$T_j = 25^\circ\text{C}$	0.80	0.90	V
		$T_j = 150^\circ\text{C}$	0.70	0.80	V
r_{CE}	$V_{GE} = 15\text{ V}$ chiplevel	$T_j = 25^\circ\text{C}$	2.2	2.6	$\text{m}\Omega$
		$T_j = 150^\circ\text{C}$	3.3	3.6	$\text{m}\Omega$
$V_{GE(th)}$	$V_{GE} = V_{CE}, I_C = 18\text{ mA}$	5	5.8	6.5	V
I_{CES}	$V_{GE} = 0\text{ V}, V_{CE} = 1200\text{ V}, T_j = 25^\circ\text{C}$			5	mA
C_{ies}	$V_{CE} = 25\text{ V}$ $V_{GE} = 0\text{ V}$	$f = 1\text{ MHz}$	27.9		nF
C_{oes}		$f = 1\text{ MHz}$	1.74		nF
C_{res}		$f = 1\text{ MHz}$	1.53		nF
Q_G	$V_{GE} = -8\text{ V} \dots +15\text{ V}$		2550		nC
R_{Gint}	$T_j = 25^\circ\text{C}$		1.7		Ω
$t_{d(on)}$	$V_{CC} = 600\text{ V}$ $I_C = 450\text{ A}$	$T_j = 150^\circ\text{C}$	195		ns
t_r	$V_{GE} = +15/-15\text{ V}$	$T_j = 150^\circ\text{C}$	67		ns
E_{on}	$R_{Gon} = 1.1\ \Omega$	$T_j = 150^\circ\text{C}$	33		mJ
$t_{d(off)}$	$R_{Goff} = 1.1\ \Omega$	$T_j = 150^\circ\text{C}$	505		ns
t_f	$di/dt_{on} = 6600\text{ A}/\mu\text{s}$ $di/dt_{off} = 3400\text{ A}/\mu\text{s}$	$T_j = 150^\circ\text{C}$	110		ns
E_{off}	$dv/dt = 4800\text{ V}/\mu\text{s}$ $L_s = 21\text{ nH}$	$T_j = 150^\circ\text{C}$	57		mJ
$R_{th(j-c)}$	per IGBT			0.066	K/W
$R_{th(c-s)}$	per IGBT ($\lambda_{grease}=0.81\text{ W}/(\text{m}^2\text{K})$)		0.03		K/W
$R_{th(c-s)}$	per IGBT, pre-applied phase change material		0.021		K/W

SEMiX453GB12E4I33p



SEMiX® 3p shunt

Trench IGBT Modules

SEMiX453GB12E4I33p

Features*

- Homogeneous Si
- Trench = Trenchgate technology
- $V_{CE(sat)}$ with positive temperature coefficient
- High short circuit capability
- Press-fit pins as auxiliary contacts
- Current sensing shunt resistor
- UL recognized, file no. E63532

Typical Applications

- AC inverter drives
- UPS
- Renewable energy systems

Remarks

- Product reliability results are valid for $T_j=150^\circ\text{C}$
- V_{isol} between temperature sensor and power section is only 2500V
- For storage and case temperature with TIM see document "TP(*) SEMiX 3p"

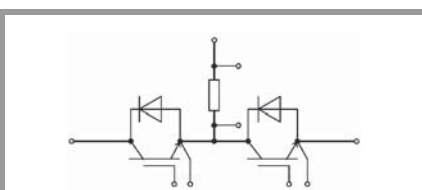

GB + shunt

Characteristics						
Symbol	Conditions		min.	typ.	max.	Unit
Inverse diode						
$V_F = V_{EC}$	$I_F = 450\text{ A}$ $V_{GE} = 0\text{ V}$ chipelevel	$T_j = 25^\circ\text{C}$		2.14	2.46	V
		$T_j = 150^\circ\text{C}$		2.07	2.38	V
V_{F0}	chipelevel	$T_j = 25^\circ\text{C}$		1.30	1.50	V
		$T_j = 150^\circ\text{C}$		0.90	1.10	V
r_F	chipelevel	$T_j = 25^\circ\text{C}$		1.87	2.1	mΩ
		$T_j = 150^\circ\text{C}$		2.6	2.8	mΩ
I_{RRM}	$I_F = 450\text{ A}$	$T_j = 150^\circ\text{C}$		455		A
Q_{rr}	$di/dt_{off} = 6800\text{ A}/\mu\text{s}$	$T_j = 150^\circ\text{C}$		85		μC
E_{rr}	$V_{GE} = -15\text{ V}$ $V_{CC} = 600\text{ V}$	$T_j = 150^\circ\text{C}$		39		mJ
$R_{th(j-c)}$	per diode				0.1	K/W
$R_{th(c-s)}$	per diode ($\lambda_{grease}=0.81\text{ W}/(\text{m}^2\text{K})$)			0.045		K/W
$R_{th(c-s)}$	per diode, pre-applied phase change material			0.036		K/W
Module						
L_{CE}				20		nH
R_{CC+EE}	measured per switch, shunt excluded	$T_C = 25^\circ\text{C}$		0.95		mΩ
		$T_C = 125^\circ\text{C}$		1.25		mΩ
$R_{th(c-s)1}$	calculated without thermal coupling			0.009		K/W
$R_{th(c-s)2}$	including thermal coupling, T_s underneath module ($\lambda_{grease}=0.81\text{ W}/(\text{m}^2\text{K})$)			0.014		K/W
$R_{th(c-s)2}$	including thermal coupling, T_s underneath module, pre-applied phase change material			0.010		K/W
M_s	to heat sink (M5)		3		6	Nm
M_t		to terminals (M6)	3		6	Nm
						Nm
w					350	g
Temperature Sensor						
R_{100}	$T_c=100^\circ\text{C}$ ($R_{25}=5\text{ k}\Omega$)			$493 \pm 5\%$		Ω
$B_{100/125}$	$R(T)=R_{100}\exp[B_{100/125}(1/T-1/T_{100})]$; $T[\text{K}]$;			$3550 \pm 2\%$		K

Characteristics						
Symbol	Conditions		min.	typ.	max.	Unit
Shunt						
R_{Shunt}	Tolerance = $\pm 1\%$, $T_c = 20^\circ\text{C}$			0.33		mΩ
α					50	ppm/K
T_{Shunt}					170	°C
$R_{th(r-c)}$					2.5	K/W
P_{Shunt}	$T_c = 80^\circ\text{C}$				36	W

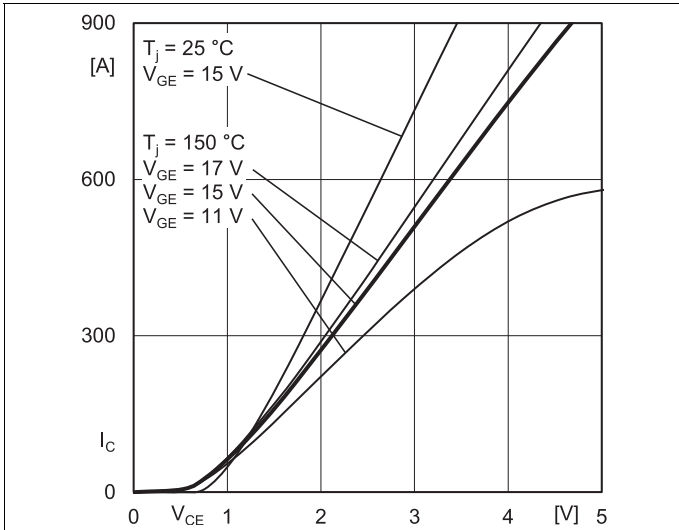

Fig. 1: Typ. output characteristic, inclusive R_{CC+EE}

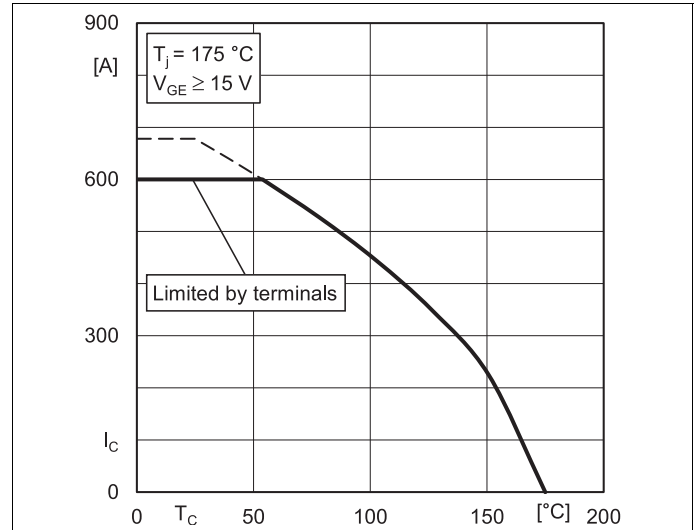

Fig. 2: Rated current vs. temperature $I_c = f(T_c)$

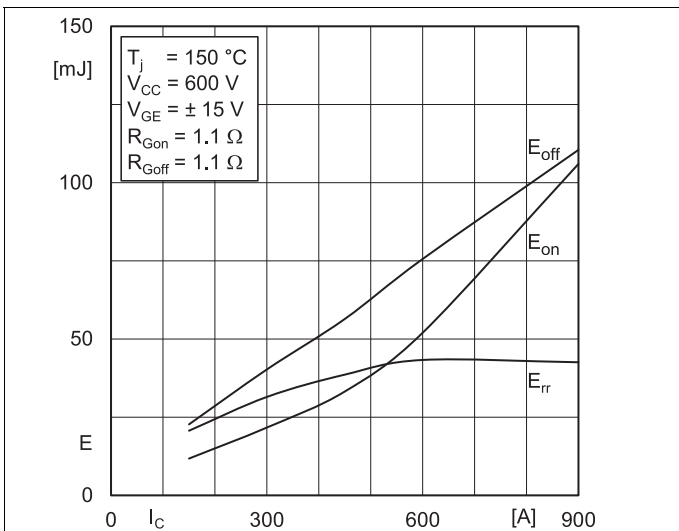

Fig. 3: Typ. turn-on /-off energy = $f(I_c)$

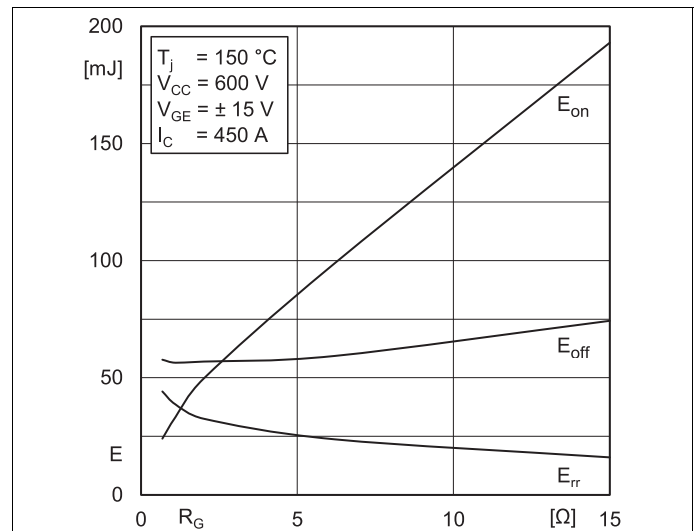

Fig. 4: Typ. turn-on /-off energy = $f(R_G)$

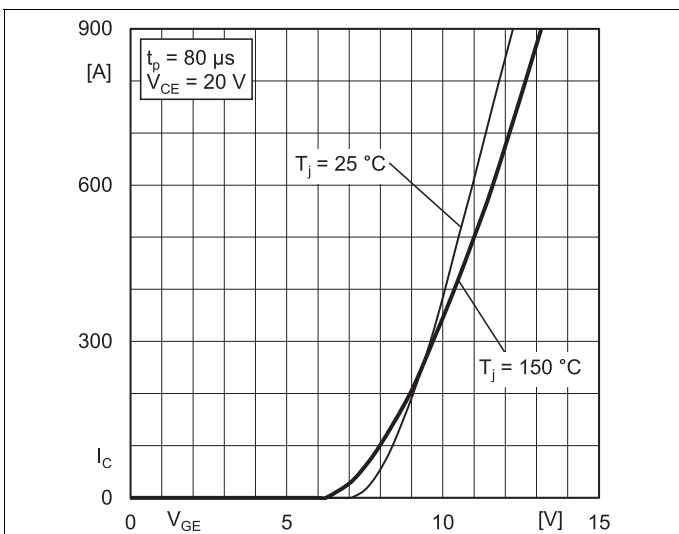

Fig. 5: Typ. transfer characteristic

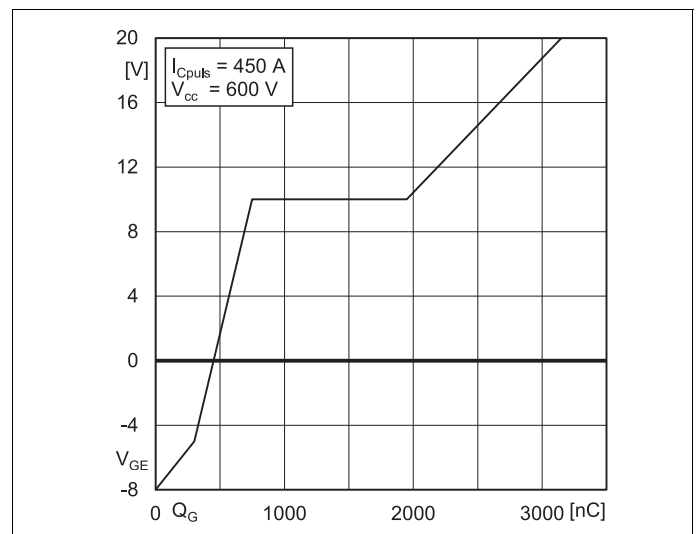

Fig. 6: Typ. gate charge characteristic

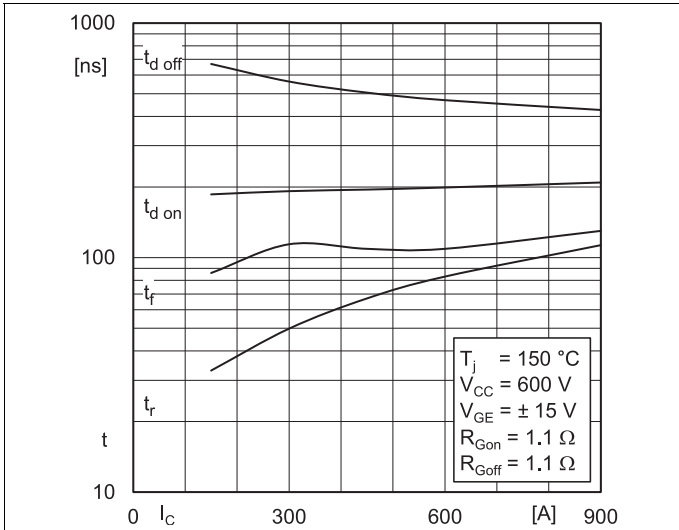

Fig. 7: Typ. switching times vs. I_C

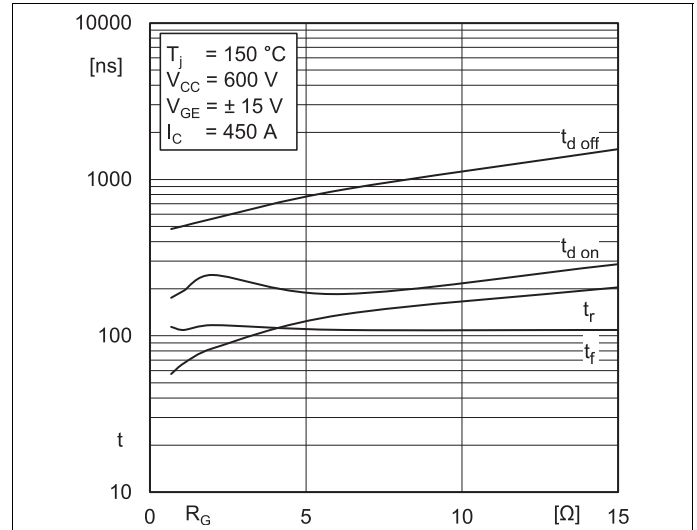

Fig. 8: Typ. switching times vs. gate resistor R_G

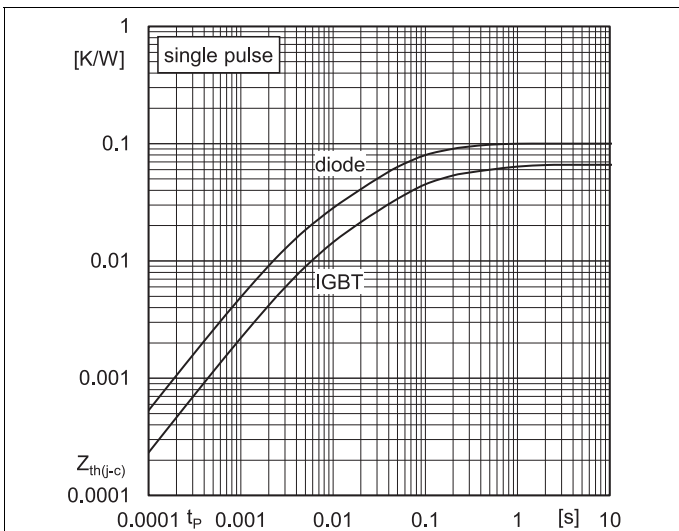

Fig. 9: Transient thermal impedance

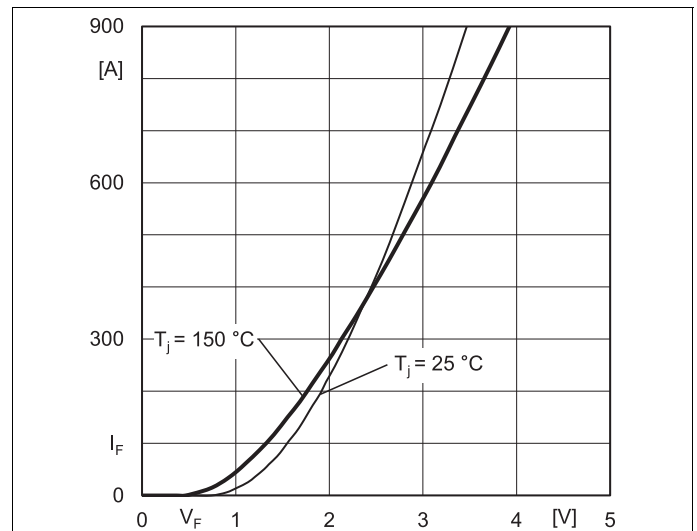

Fig. 10: Typ. CAL diode forward charact., incl. R_{CC+EE}

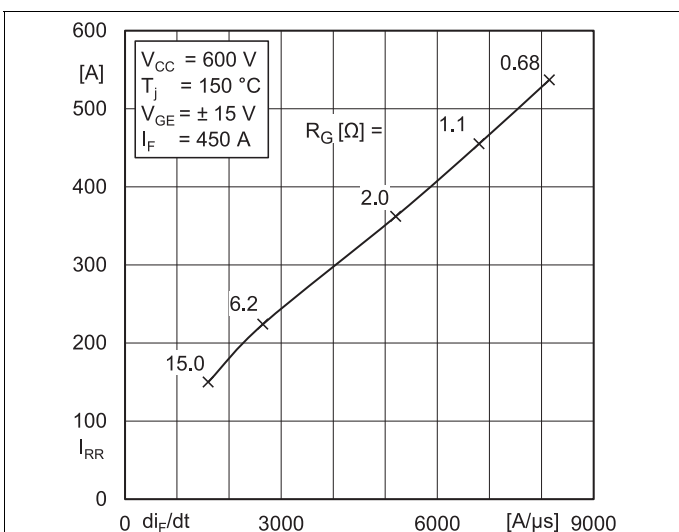

Fig. 11: Typ. CAL diode peak reverse recovery current

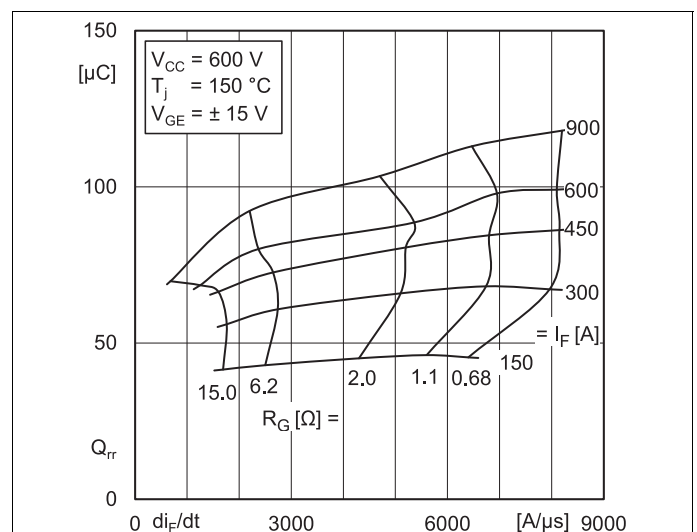
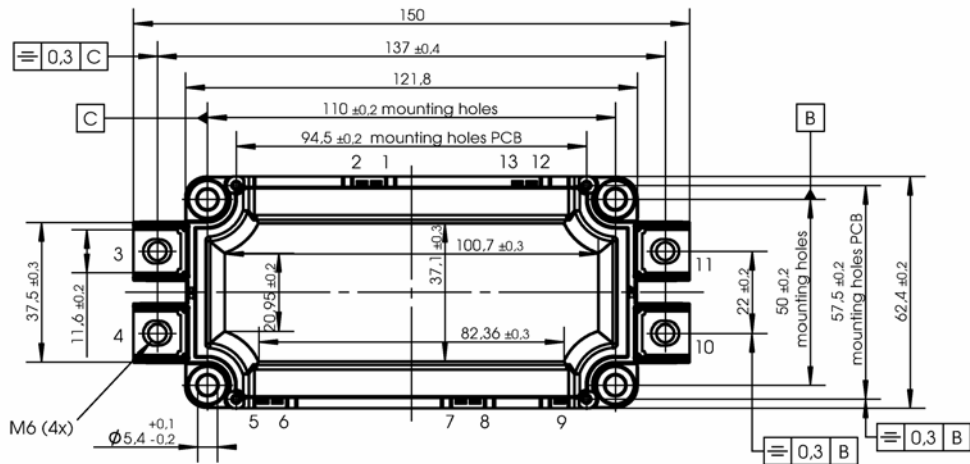
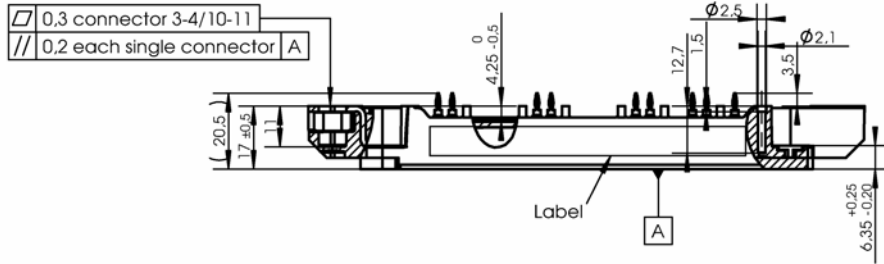

Fig. 12: Typ. CAL diode recovery charge

SEMiX453GB12E4I33p

Package outline



PCB drillhole pattern

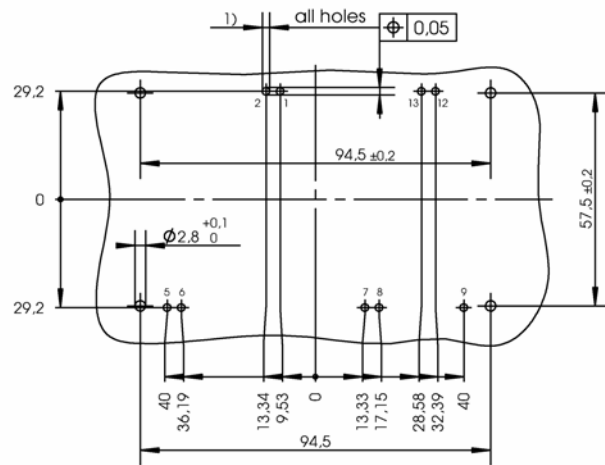

Dimensions valid in mounted status

1) PCB hole specification see Mounting Instructions SEMiX press-fit

SEMiX 3p shunt

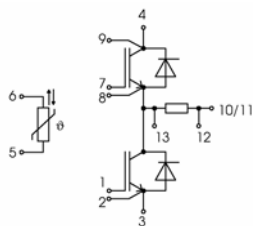

pinout

This is an electrostatic discharge sensitive device (ESDS), international standard IEC 60747-1, chapter IX.

***IMPORTANT INFORMATION AND WARNINGS**

The specifications of SEMIKRON products may not be considered as guarantee or assurance of product characteristics ("Beschaffenheitsgarantie"). The specifications of SEMIKRON products describe only the usual characteristics of products to be expected in typical applications, which may still vary depending on the specific application. Therefore, products must be tested for the respective application in advance. Application adjustments may be necessary. The user of SEMIKRON products is responsible for the safety of their applications embedding SEMIKRON products and must take adequate safety measures to prevent the applications from causing a physical injury, fire or other problem if any of SEMIKRON products become faulty. The user is responsible to make sure that the application design is compliant with all applicable laws, regulations, norms and standards. Except as otherwise explicitly approved by SEMIKRON in a written document signed by authorized representatives of SEMIKRON, SEMIKRON products may not be used in any applications where a failure of the product or any consequences of the use thereof can reasonably be expected to result in personal injury. No representation or warranty is given and no liability is assumed with respect to the accuracy, completeness and/or use of any information herein, including without limitation, warranties of non-infringement of intellectual property rights of any third party. SEMIKRON does not assume any liability arising out of the applications or use of any product; neither does it convey any license under its patent rights, copyrights, trade secrets or other intellectual property rights, nor the rights of others. SEMIKRON makes no representation or warranty of non-infringement or alleged non-infringement of intellectual property rights of any third party which may arise from applications. Due to technical requirements our products may contain dangerous substances. For information on the types in question please contact the nearest SEMIKRON sales office. This document supersedes and replaces all information previously supplied and may be superseded by updates. SEMIKRON reserves the right to make changes.