

# SKKT 27, SKKT 27B, SKKH 27



**SEMIPACK® 1**

## Thyristor / Diode Modules

**SKKT 27**

**SKKT 27B**

**SKKH 27**

### Features

- Heat transfer through aluminium oxide ceramic isolated metal baseplate
- Hard soldered joints for high reliability
- UL recognized, file no. E 63 532

### Typical Applications\*

- DC motor control (e. g. for machine tools)
- AC motor soft starters
- Temperature control (e. g. for ovens, chemical processes)
- Professional light dimming (studios, theaters)

1) See the assembly instructions

| $V_{RSM}$<br>V | $V_{RRM}, V_{DRM}$<br>V | $I_{TRMS} = 50$ A (maximum value for continuous operation) |             |             |
|----------------|-------------------------|--|-------------|-------------|
|                |                         | $I_{TAV} = 27$ A (sin. 180; $T_c = 82$ °C)                 |             |             |
| 900            | 800                     | SKKT 27/08E  | SKKT 27B08E | SKKH 27/08E |
| 1300           | 1200                    | SKKT 27/12E  | SKKT 27B12E | SKKH 27/12E |
| 1500           | 1400                    | SKKT 27/14E  | SKKT 27B14E | SKKH 27/14E |
| 1700           | 1600                    | SKKT 27/16E  | SKKT 27B16E | SKKH 27/16E |
| 1900           | 1800                    |  |             | SKKH 27/18E |

| Symbol           | Conditions  | Values                 | Units            |
|------------------|---|------------------------|------------------|
| $I_{TAV}$        | sin. 180; $T_c = 85$ (100) °C;                          | 25 (18)                | A                |
| $I_D$            | P3/180; $T_a = 45$ °C; B2 / B6                          | 38 / 50                | A                |
|                  | P3/180F; $T_a = 35$ °C; B2 / B6                         | 60 / 77                | A                |
| $I_{RMS}$        | P3/180; $T_a = 45$ °C; W1 / W3                          | 52 / 3 x 37            | A                |
| $I_{TSM}$        | $T_{vj} = 25$ °C; 10 ms                                 | 550                    | A                |
|                  | $T_{vj} = 125$ °C; 10 ms                                | 480                    | A                |
| $i^2t$           | $T_{vj} = 25$ °C; 8,3 ... 10 ms                         | 1500                   | A <sup>2</sup> s |
|                  | $T_{vj} = 125$ °C; 8,3 ... 10 ms                        | 1150                   | A <sup>2</sup> s |
| $V_T$            | $T_{vj} = 25$ °C; $I_T = 75$ A                          | max. 1,8               | V                |
| $V_{T(TO)}$      | $T_{vj} = 125$ °C                                       | max. 0,9               | V                |
| $r_T$            | $T_{vj} = 125$ °C                                       | max. 12                | mΩ               |
| $I_{DD}; I_{RD}$ | $T_{vj} = 125$ °C; $V_{RD} = V_{RRM}; V_{DD} = V_{DRM}$ | max. 10                | mA               |
| $t_{gd}$         | $T_{vj} = 25$ °C; $I_G = 1$ A; $di_G/dt = 1$ A/μs       | 1                      | μs               |
| $t_{gr}$         | $V_D = 0,67 * V_{DRM}$                                  | 1                      | μs               |
| $(di/dt)_{cr}$   | $T_{vj} = 125$ °C                                       | max. 150               | A/μs             |
| $(dv/dt)_{cr}$   | $T_{vj} = 125$ °C                                       | max. 1000              | V/μs             |
| $t_q$            | $T_{vj} = 125$ °C                                       | 80                     | μs               |
| $I_H$            | $T_{vj} = 25$ °C; typ. / max.                           | 100 / 200              | mA               |
| $I_L$            | $T_{vj} = 25$ °C; $R_G = 33$ Ω; typ. / max.             | 250 / 400              | mA               |
| $V_{GT}$         | $T_{vj} = 25$ °C; d.c.                                  | min. 3                 | V                |
| $I_{GT}$         | $T_{vj} = 25$ °C; d.c.                                  | min. 150               | mA               |
| $V_{GD}$         | $T_{vj} = 125$ °C; d.c.                                 | max. 0,25              | V                |
| $I_{GD}$         | $T_{vj} = 125$ °C; d.c.                                 | max. 5                 | mA               |
| $R_{th(j-c)}$    | cont.; per thyristor / per module                       | 0,9 / 0,45             | K/W              |
| $R_{th(j-c)}$    | sin. 180; per thyristor / per module                    | 0,95 / 0,48            | K/W              |
| $R_{th(j-c)}$    | rec. 120; per thyristor / per module                    | 1 / 0,5                | K/W              |
| $R_{th(c-s)}$    | per thyristor / per module                              | 0,2 / 0,1              | K/W              |
| $T_{vj}$         |   | - 40 ... + 125         | °C               |
| $T_{stg}$        |   | - 40 ... + 125         | °C               |
| $V_{isol}$       | a. c. 50 Hz; r.m.s.; 1 s / 1 min.                       | 3600 / 3000            | V~               |
| $M_s$            | to heatsink   | 5 ± 15 % <sup>1)</sup> | Nm               |
| $M_t$            | to terminals  | 3 ± 15 %               | Nm               |
| $a$              |   | 5 * 9,81               | m/s <sup>2</sup> |
| $m$              | approx.   | 95                     | g                |
| Case             | SKKT  | A 46                   |                  |
|                  | SKKT ...B   | A 48                   |                  |
|                  | SKKH  | A 47                   |                  |



**SKKT**

**SKKH**

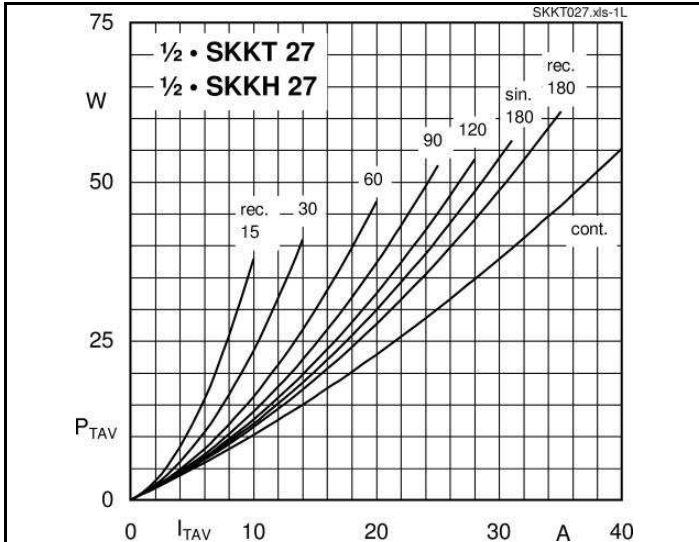

Fig. 1L Power dissipation per thyristor vs. on-state current

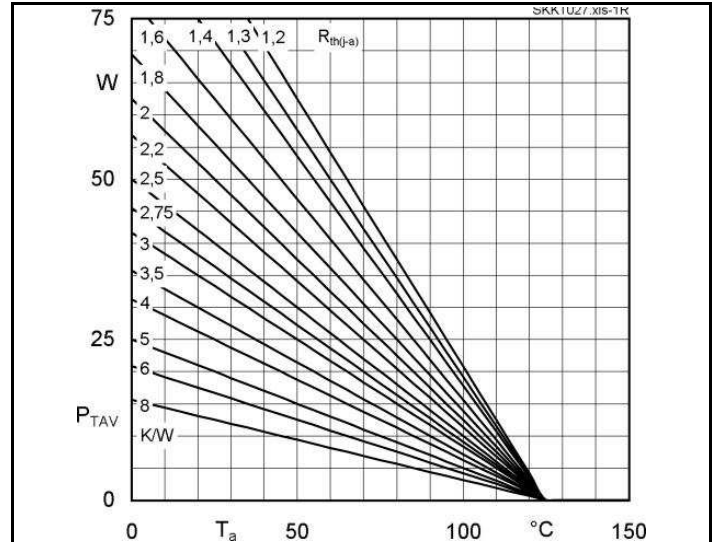

Fig. 1R Power dissipation per thyristor vs. ambient temp.

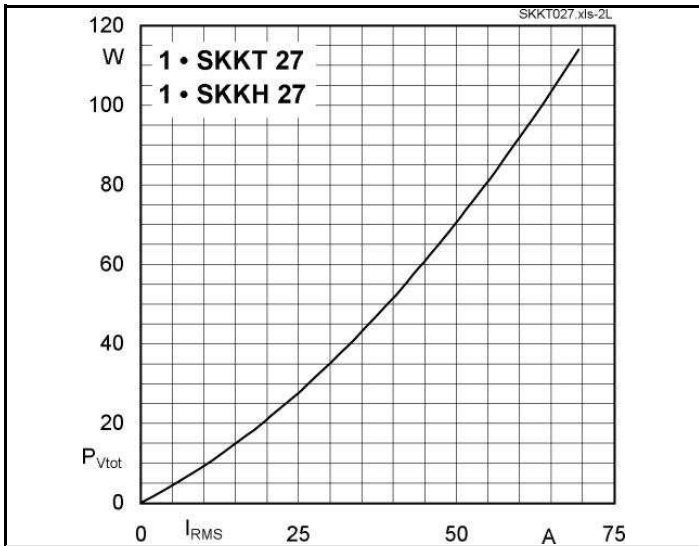

Fig. 2L Power dissipation per module vs. rms current

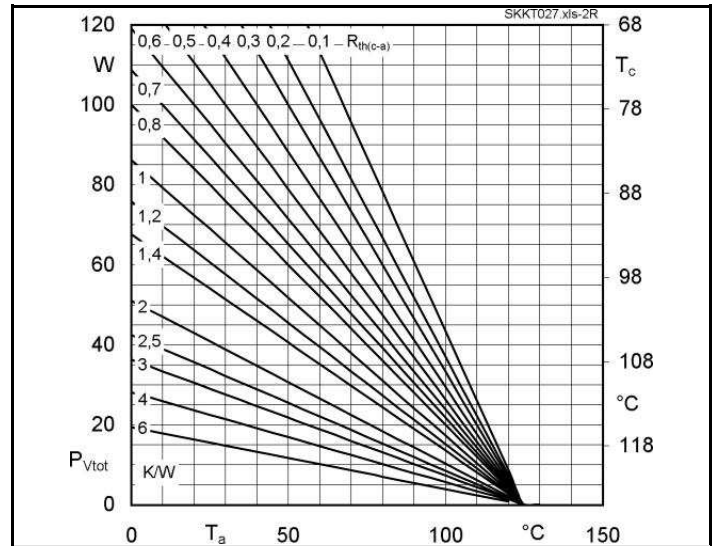

Fig. 2R Power dissipation per module vs. case temp.

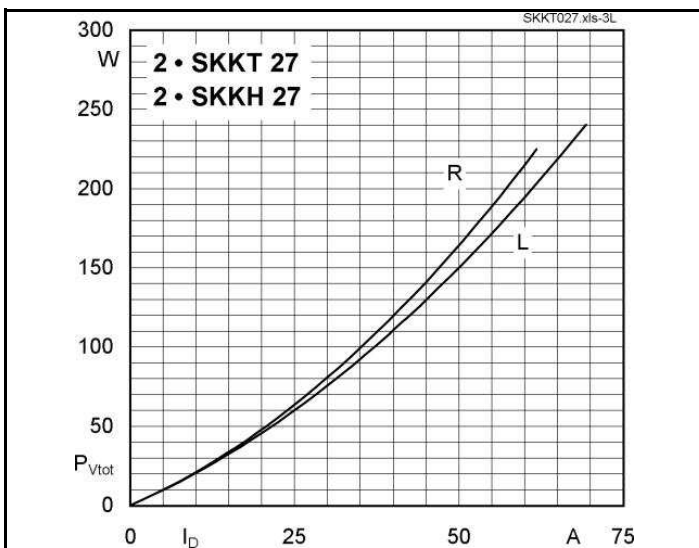

Fig. 3L Power dissipation of two modules vs. direct current

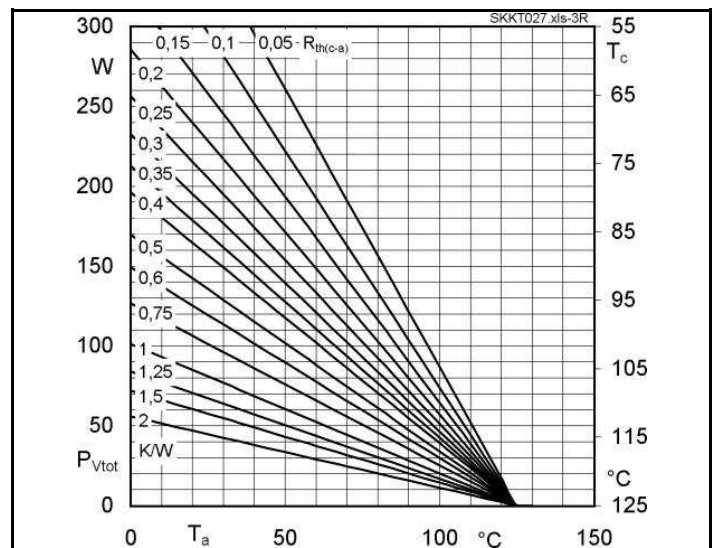
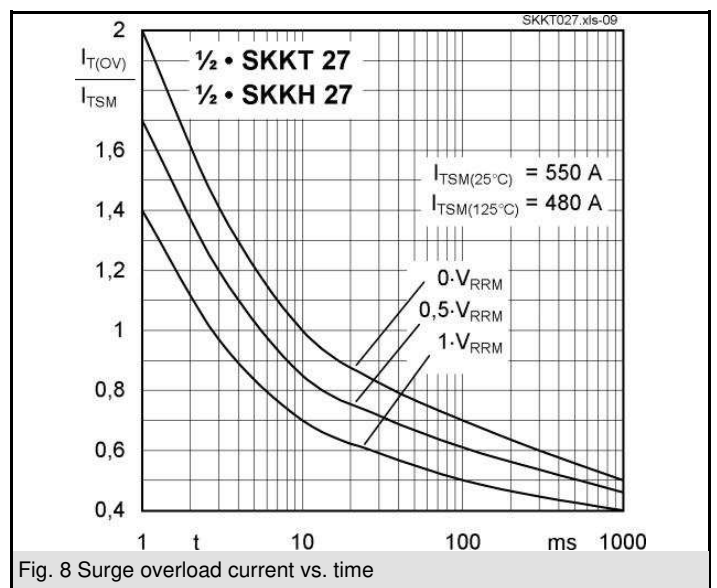
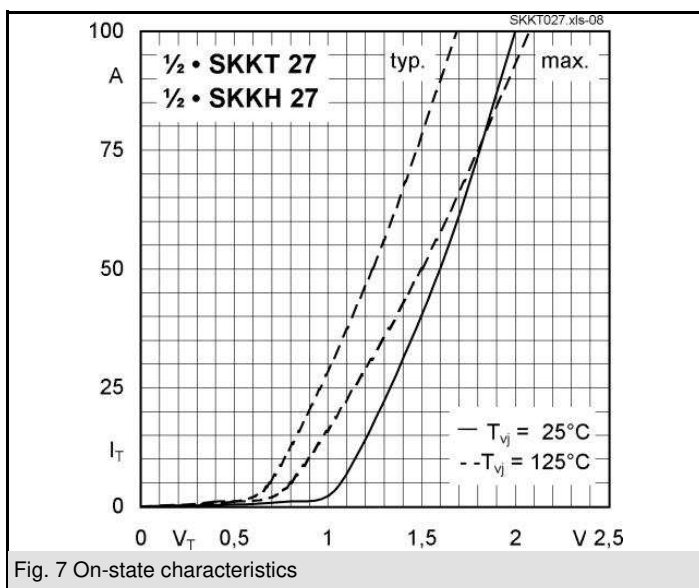
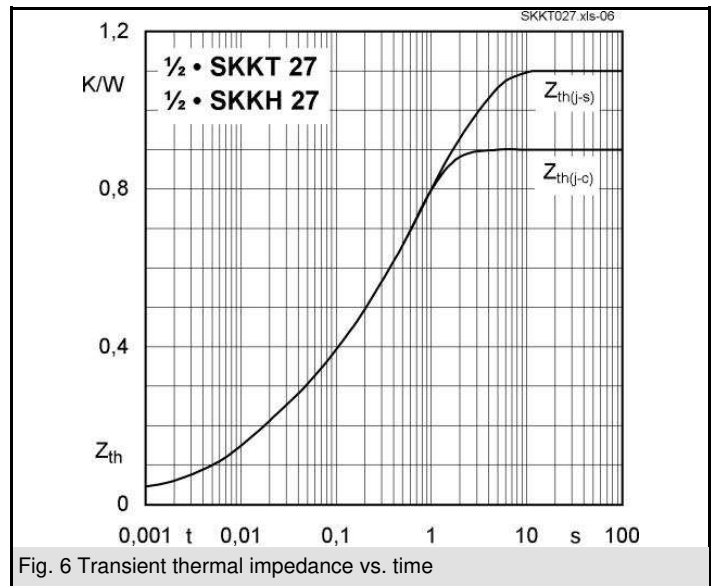
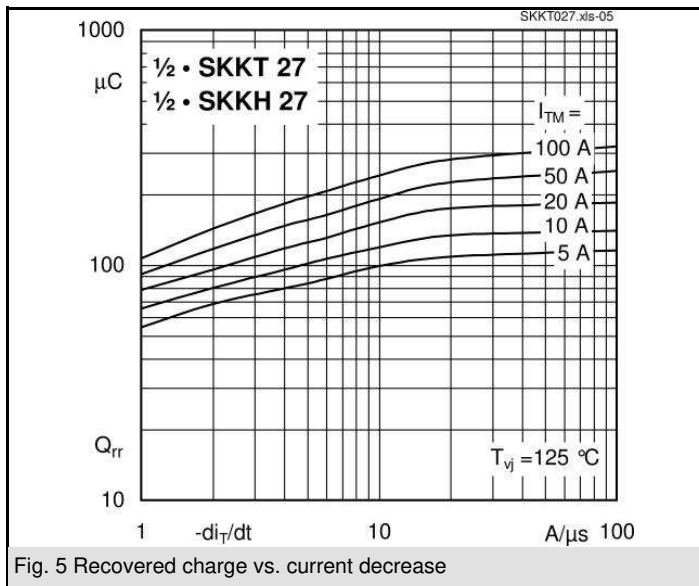
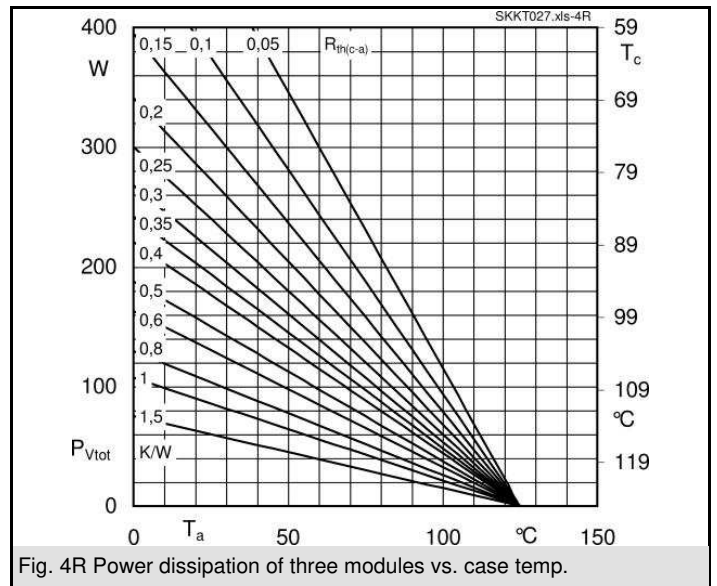
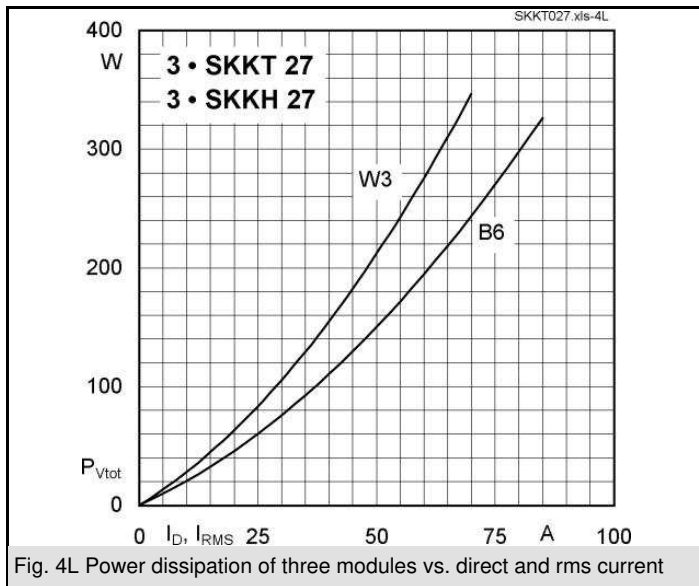
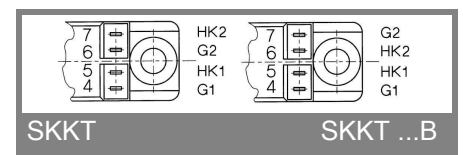
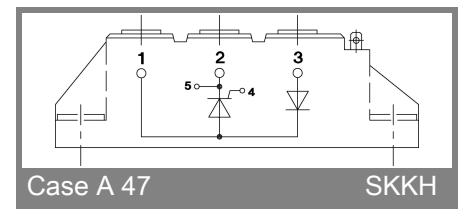
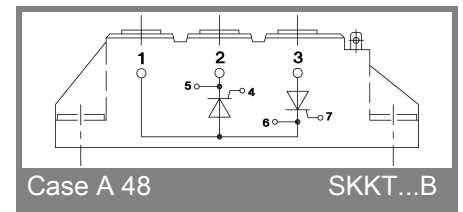
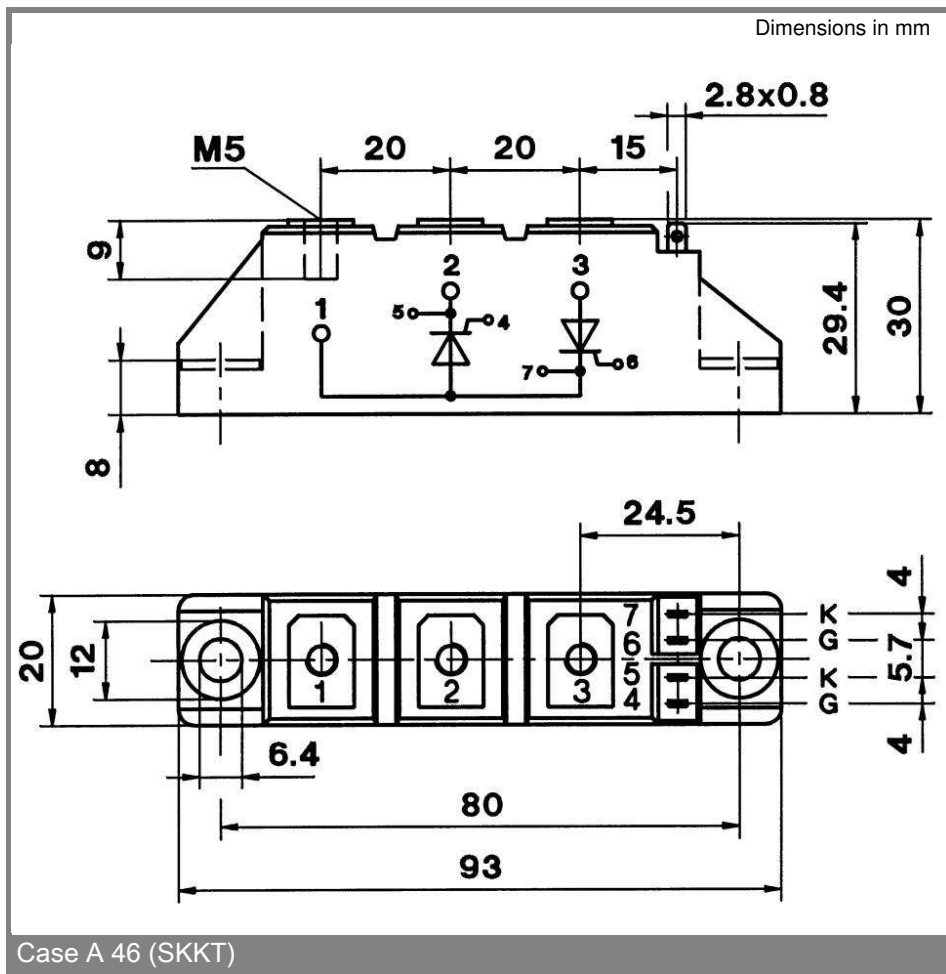
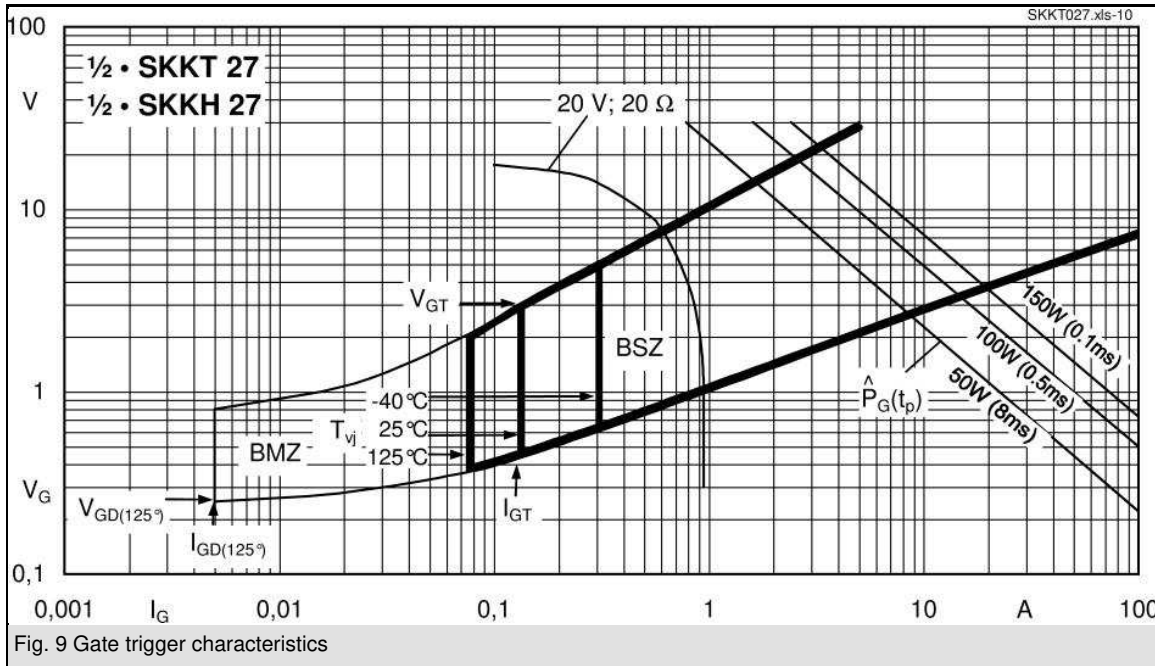

Fig. 3R Power dissipation of two modules vs. case temp.

# SKKT 27, SKKT 27B, SKKH 27





\* The specifications of our components may not be considered as an assurance of component characteristics. Components have to be tested for the respective application. Adjustments may be necessary. The use of SEMIKRON products in life support appliances and systems is subject to prior specification and written approval by SEMIKRON. We therefore strongly recommend prior consultation of our personal.