

SKM 300GB125D

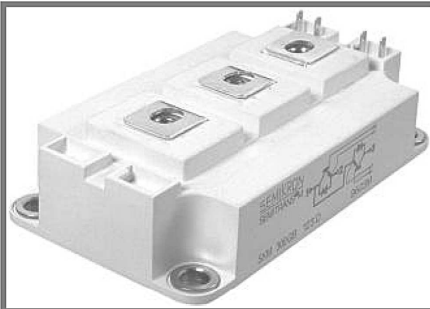

SEMITRANS® 3

Ultra Fast IGBT Module

SKM 300GB125D

Features

- NPT - Non punch-through IGBT
- Low inductance case
- Short tail current with low temperature dependence
- High short circuit capability, self limiting
- Fast & soft inverse CAL diodes
- Isolated copper baseplate using DCB Direct Copper Bonding Technology
- Large clearance (10 mm) and creepage distances (20 mm)

Typical Applications*

- Switched mode power supplies at $f_{sw} > 20$ kHz
- Resonant inverters up to 100 kHz
- Inductive heating
- UPS Uninterruptable power supplies at $f_{sw} > 20$ kHz
- Electronic welders at $f_{sw} > 20$ kHz



GB

Absolute Maximum Ratings		$T_c = 25\text{ }^\circ\text{C}$, unless otherwise specified		
Symbol	Conditions	Values		Units
IGBT				
V_{CES}	$T_j = 25\text{ }^\circ\text{C}$	1200		V
I_C	$T_j = 150\text{ }^\circ\text{C}$	$T_{case} = 25\text{ }^\circ\text{C}$	300	A
		$T_{case} = 80\text{ }^\circ\text{C}$	210	A
I_{CRM}	$I_{CRM} = 2 \times I_{Cnom}$	400		A
V_{GES}		± 20		V
t_{psc}	$V_{CC} = 600\text{ V}; V_{GE} \leq 20\text{ V}; T_j = 125\text{ }^\circ\text{C}$ $V_{CES} < 1200\text{ V}$	10		μs
Inverse Diode				
I_F	$T_j = 150\text{ }^\circ\text{C}$	$T_{case} = 25\text{ }^\circ\text{C}$	260	A
		$T_{case} = 80\text{ }^\circ\text{C}$	180	A
I_{FRM}	$I_{FRM} = 2 \times I_{Fnom}$	400		A
I_{FSM}	$t_p = 10\text{ ms}; \text{sin.}$	$T_j = 150\text{ }^\circ\text{C}$	1800	A
Module				
$I_{t(RMS)}$		500		A
T_{vj}		- 40...+ 150		$^\circ\text{C}$
T_{stg}		- 40...+ 125		$^\circ\text{C}$
V_{isol}	AC, 1 min.	4000		V

Characteristics		$T_c = 25\text{ }^\circ\text{C}$, unless otherwise specified			
Symbol	Conditions	min.	typ.	max.	Units
IGBT					
$V_{GE(th)}$	$V_{GE} = V_{CE}; I_C = 8\text{ mA}$	4,5	5,5	6,5	V
I_{CES}	$V_{GE} = 0\text{ V}, V_{CE} = V_{CES}$		0,1	0,3	mA
V_{CE0}		$T_j = 25\text{ }^\circ\text{C}$	1,5	1,75	V
		$T_j = 125\text{ }^\circ\text{C}$	1,7		V
r_{CE}	$V_{GE} = 15\text{ V}$	$T_j = 25\text{ }^\circ\text{C}$	9	10,5	$\text{m}\Omega$
		$T_j = 125\text{ }^\circ\text{C}$	11,5		$\text{m}\Omega$
$V_{CE(sat)}$	$I_{Cnom} = 200\text{ A}, V_{GE} = 15\text{ V}$		3,3	3,85	V
C_{ies}	$V_{CE} = 25, V_{GE} = 0\text{ V}$	$f = 1\text{ MHz}$	18	24	nF
C_{oes}			2,5	3,2	nF
C_{res}			1	1,3	nF
Q_G	$V_{GE} = 0\text{ V} - +20\text{ V}$	2000		nC	
R_{Gint}	$T_j = \text{ }^\circ\text{C}$	2,5		Ω	
$t_{d(on)}$	$R_{Gon} = 3\text{ }\Omega$	$V_{CC} = 600\text{ V}$ $I_C = 200\text{ A}$	130		ns
t_r			40		ns
E_{on}			16		mJ
$t_{d(off)}$	$R_{Goff} = 3\text{ }\Omega$	$T_j = 125\text{ }^\circ\text{C}$ $V_{GE} = \pm 15\text{ V}$	460		ns
t_f			30		ns
E_{off}					mJ
$R_{th(j-c)}$	per IGBT	0,075		K/W	

SKM 300GB125D

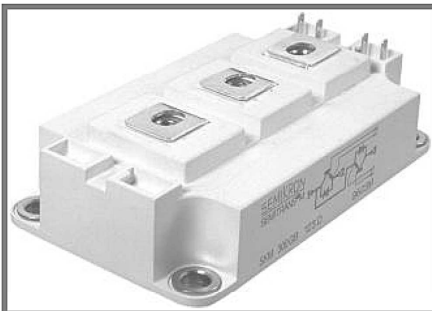

SEMITRANS® 3

Ultra Fast IGBT Module

SKM 300GB125D

Features

- NPT - Non punch-through IGBT
- Low inductance case
- Short tail current with low temperature dependence
- High short circuit capability, self limiting
- Fast & soft inverse CAL diodes
- Isolated copper baseplate using DCB Direct Copper Bonding Technology
- Large clearance (10 mm) and creepage distances (20 mm)

Typical Applications*

- Switched mode power supplies at $f_{sw} > 20$ kHz
- Resonant inverters up to 100 kHz
- Inductive heating
- UPS Uninterruptable power supplies at $f_{sw} > 20$ kHz
- Electronic welders at $f_{sw} > 20$ kHz



GB

Characteristics

Symbol	Conditions	min.	typ.	max.	Units
Inverse Diode					
$V_F = V_{EC}$	$I_{Fnom} = 200$ A; $V_{GE} = 0$ V				
	$T_j = 25$ °C _{chiplev.}		2	2,5	V
	$T_j = 125$ °C _{chiplev.}		1,8		V
V_{F0}					
	$T_j = 25$ °C		1,1	1,2	V
	$T_j = 125$ °C				V
r_F					
	$T_j = 25$ °C		4,5	6,5	mΩ
	$T_j = 125$ °C				mΩ
I_{RRM}	$I_F = 200$ A		340		A
Q_{rr}	$di/dt = 8000$ A/μs		46		μC
E_{rr}	$V_{GE} = 0$ V; $V_{CC} = 600$ V				mJ
$R_{th(j-c)D}$	per diode			0,18	K/W
Module					
L_{CE}			15	20	nH
R_{CC+EE}	res., terminal-chip	$T_{case} = 25$ °C	0,35		mΩ
		$T_{case} = 125$ °C	0,5		mΩ
$R_{th(c-s)}$	per module			0,038	K/W
M_s	to heat sink M6		3	5	Nm
M_t	to terminals M6		2,5	5	Nm
w				325	g

This is an electrostatic discharge sensitive device (ESDS), international standard IEC 60747-1, Chapter IX.

* The specifications of our components may not be considered as an assurance of component characteristics. Components have to be tested for the respective application. Adjustments may be necessary. The use of SEMIKRON products in life support appliances and systems is subject to prior specification and written approval by SEMIKRON. We therefore strongly recommend prior consultation of our personal.

SKM 300GB125D

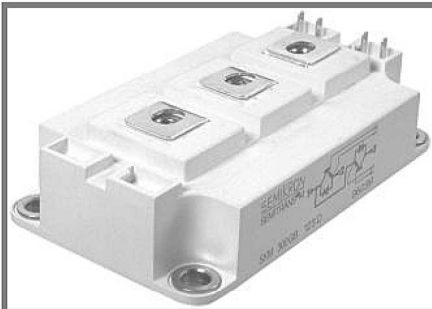

SEMITRANS® 3

Ultra Fast IGBT Module

SKM 300GB125D

Features

- NPT - Non punch-through IGBT
- Low inductance case
- Short tail current with low temperature dependence
- High short circuit capability, self limiting
- Fast & soft inverse CAL diodes
- Isolated copper baseplate using DCB Direct Copper Bonding Technology
- Large clearance (10 mm) and creepage distances (20 mm)

Typical Applications*

- Switched mode power supplies at $f_{sw} > 20$ kHz
- Resonant inverters up to 100 kHz
- Inductive heating
- UPS Uninterruptable power supplies at $f_{sw} > 20$ kHz
- Electronic welders at $f_{sw} > 20$ kHz



GB

Z_{th}			
Symbol	Conditions	Values	Units
$Z_{th(j-c)I}$			
$R_{\theta j-c}$	$i = 1$	53	mK/W
$R_{\theta j-c}$	$i = 2$	18,5	mK/W
$R_{\theta j-c}$	$i = 3$	3,1	mK/W
$R_{\theta j-c}$	$i = 4$	0,4	mK/W
$\tau_{\theta j-c}$	$i = 1$	0,04	s
$\tau_{\theta j-c}$	$i = 2$	0,0189	s
$\tau_{\theta j-c}$	$i = 3$	0,0017	s
$\tau_{\theta j-c}$	$i = 4$	0,003	s
$Z_{th(j-c)D}$			
$R_{\theta j-c}$	$i = 1$	115	mK/W
$R_{\theta j-c}$	$i = 2$	52	mK/W
$R_{\theta j-c}$	$i = 3$	11	mK/W
$R_{\theta j-c}$	$i = 4$	2	mK/W
$\tau_{\theta j-c}$	$i = 1$	0,0366	s
$\tau_{\theta j-c}$	$i = 2$	0,0113	s
$\tau_{\theta j-c}$	$i = 3$	0,003	s
$\tau_{\theta j-c}$	$i = 4$	0,0002	s

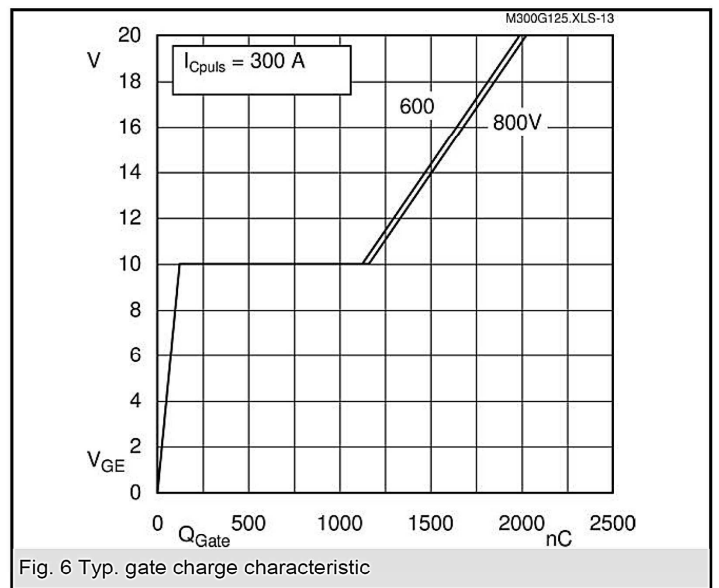
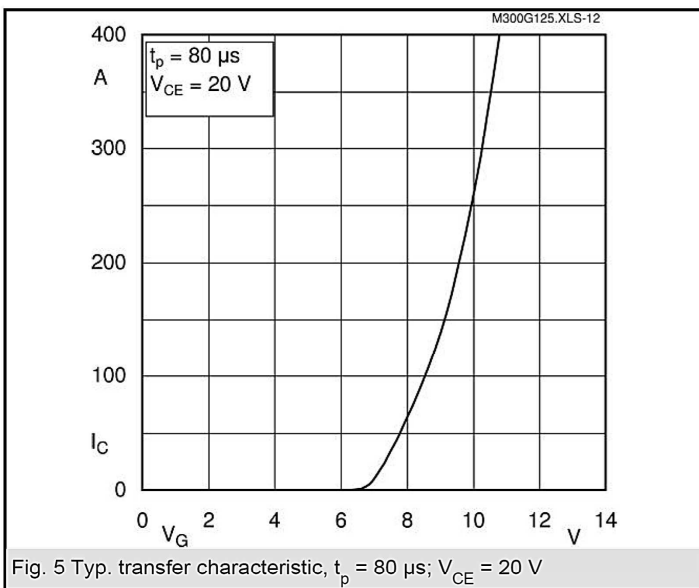
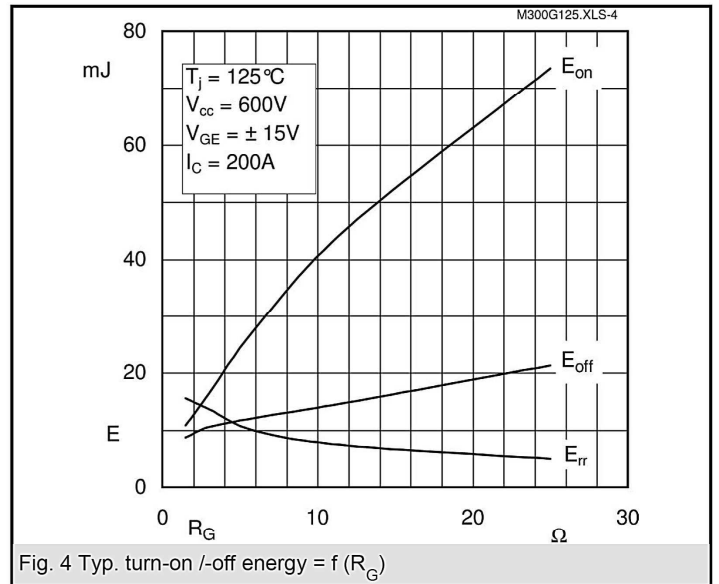
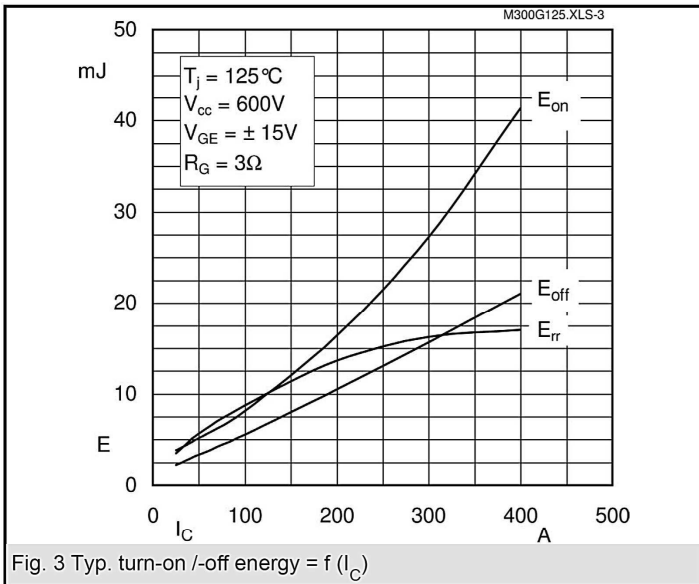
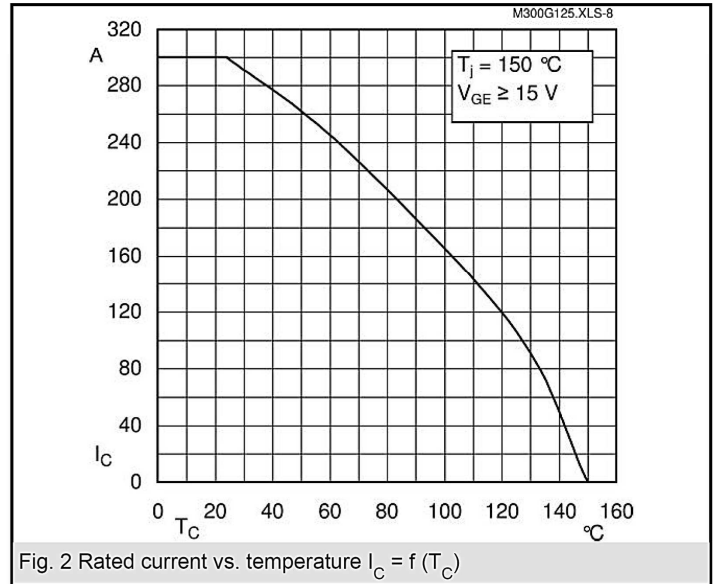
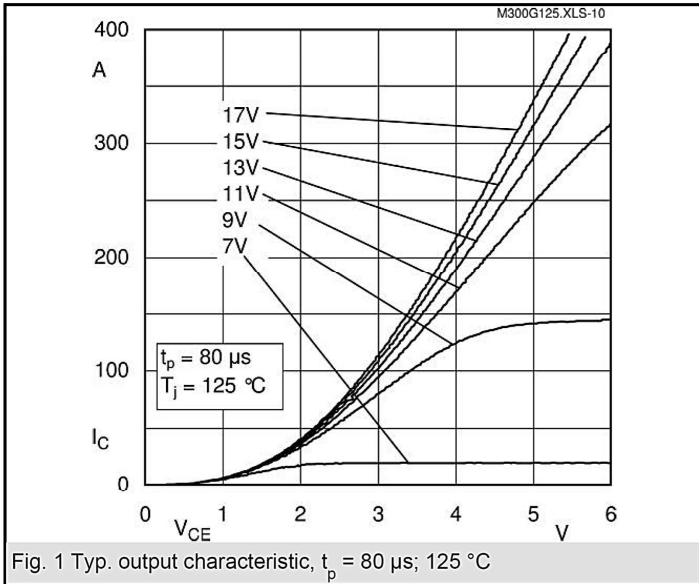

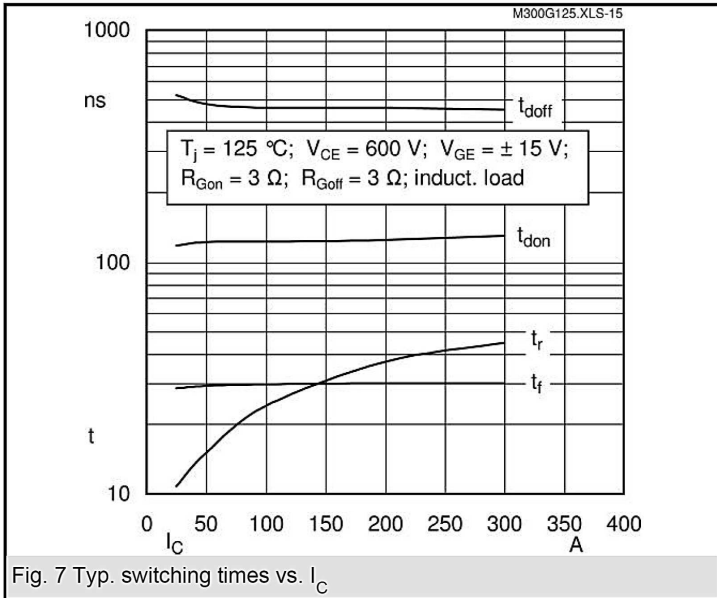

Fig. 7 Typ. switching times vs. I_C

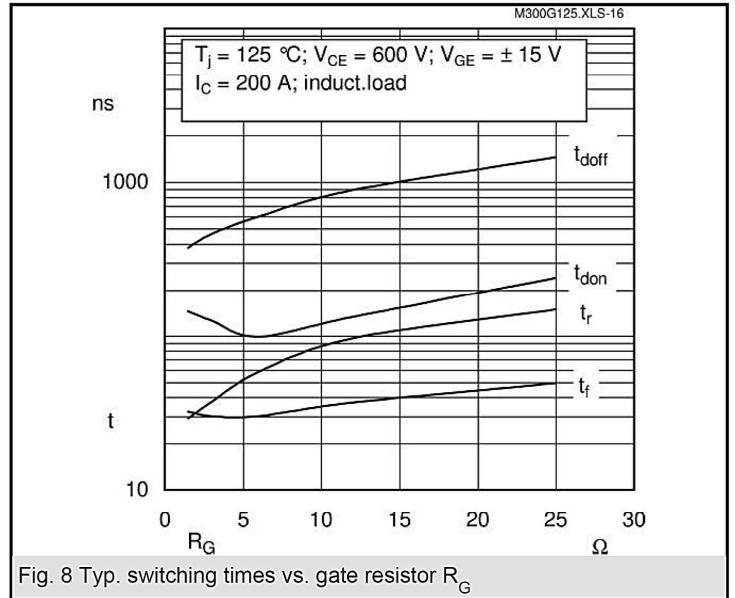

Fig. 8 Typ. switching times vs. gate resistor R_G

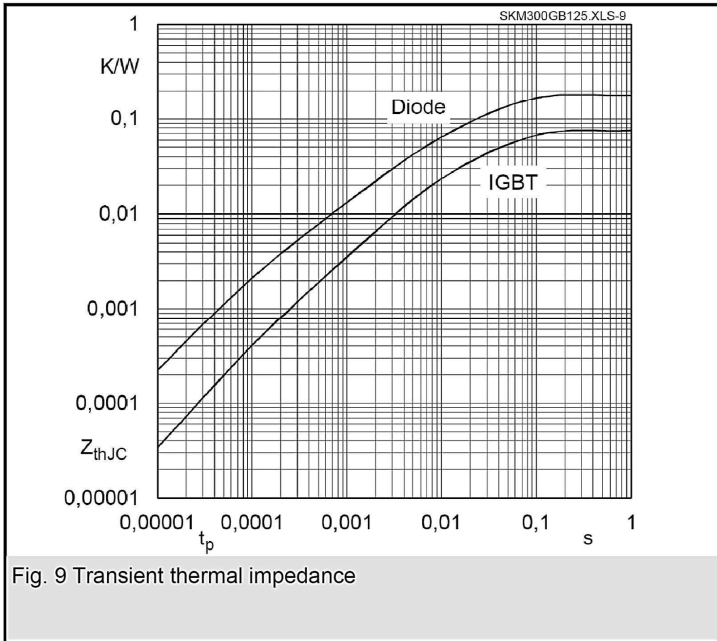

Fig. 9 Transient thermal impedance

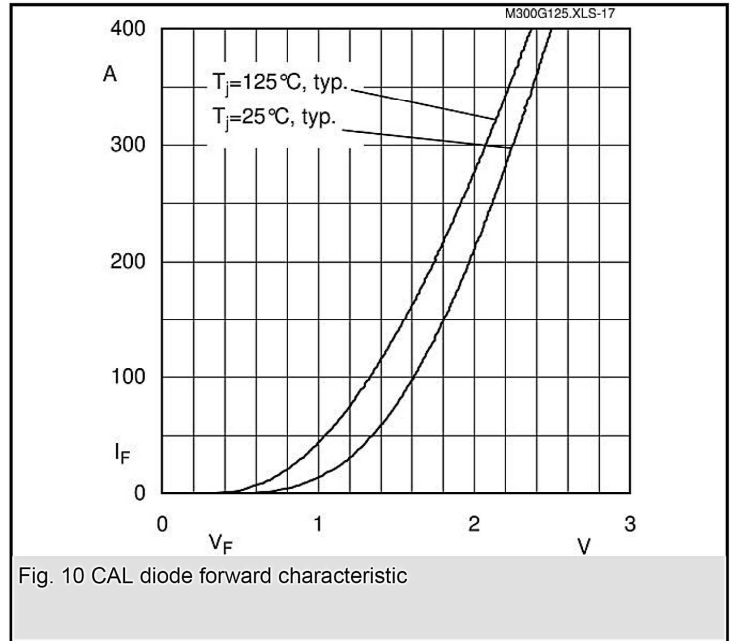

Fig. 10 CAL diode forward characteristic

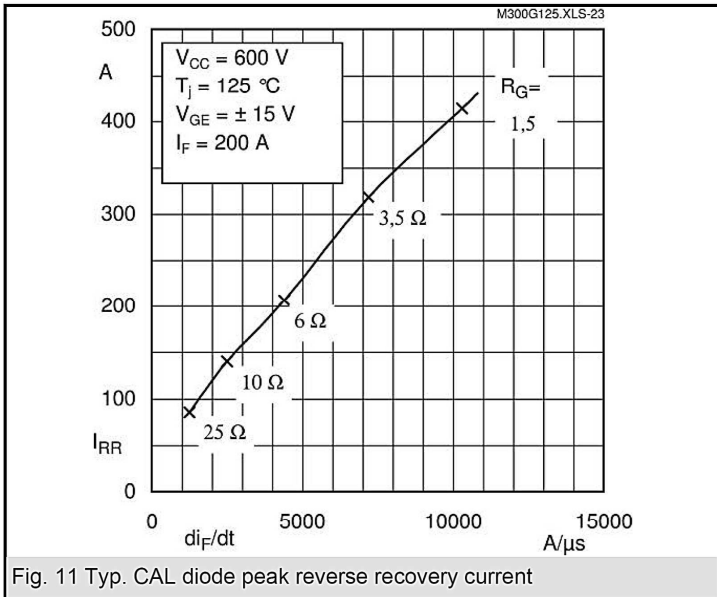

Fig. 11 Typ. CAL diode peak reverse recovery current

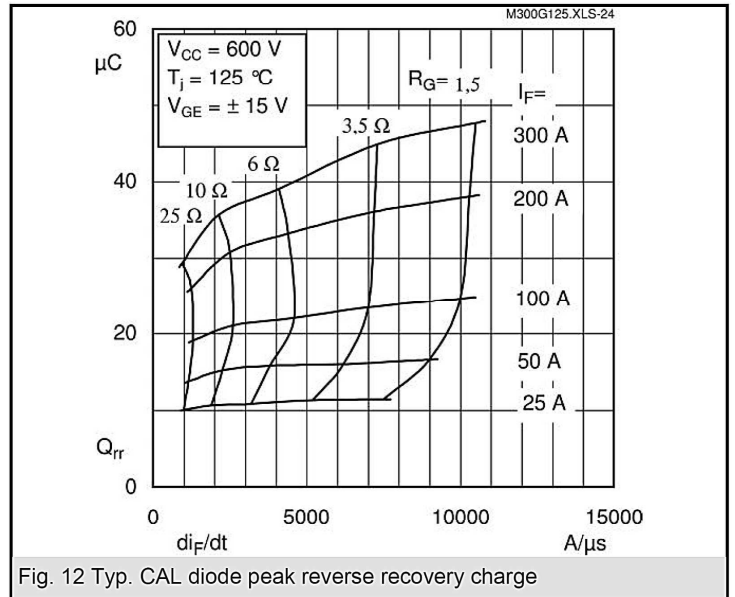

Fig. 12 Typ. CAL diode peak reverse recovery charge

SKM 300GB125D

UL Recognized

CASED56

File 63 532

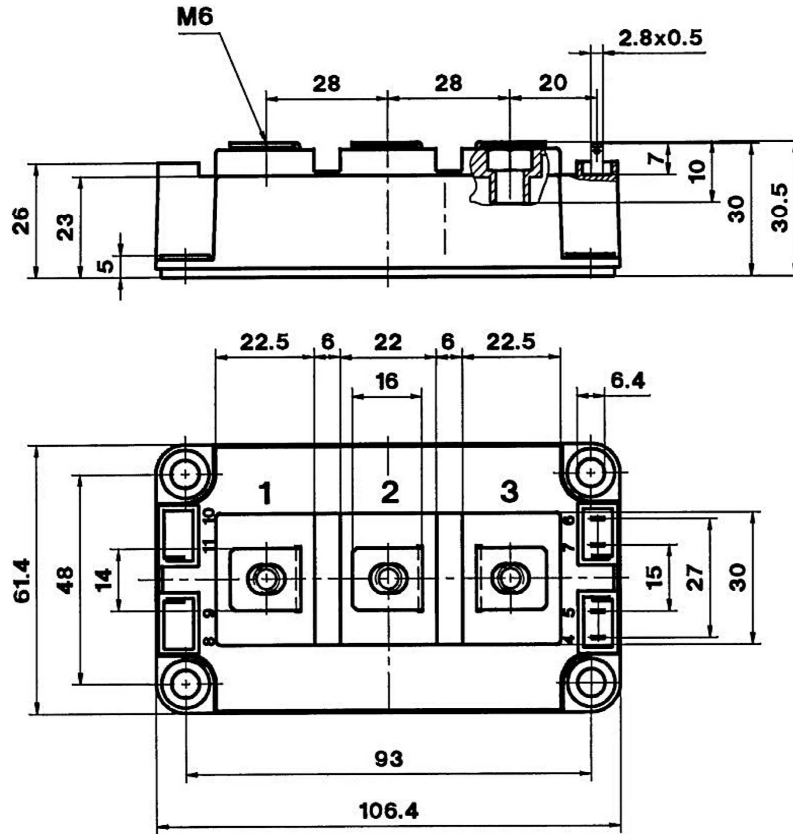

Case D 56

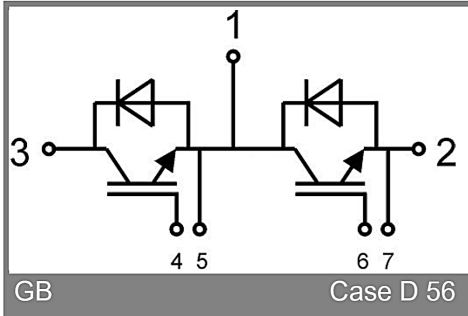

GB

Case D 56