



SEMITOP® 1

Antiparallel Thyristor Module

SK 25 KQ

Preliminary Data

Features

- Compact Design
- One screw mounting
- Heat transfer and isolation through direct copper bonded aluminium oxide ceramic (DBC)
- Glass passivated thyristor chips
- Up to 1600V reverse voltage
- UL recognized, file no. E 63 532

Typical Applications

- Soft starters
- Light control (studios, theaters...)
- Temperature control

V_{RSM} V	V_{RRM}, V_{DRM} V	$I_{RMS} = 29 \text{ A A (full conduction)}$ ($T_s = 85^\circ \text{C}$)
900	800	SK 25 KQ 08
1300	1200	SK 25 KQ 12
1700	1600	SK 25 KQ 16

Symbol	Conditions	Values	Units
I_{RMS}	W1C ; sin. 180° ; $T_s = 100^\circ \text{C}$	20	A
	W1C ; sin. 180° ; $T_s = 85^\circ \text{C}$	29	A
I_{TSM}	$T_{vj} = 25^\circ \text{C}$; 10 ms	320	A
	$T_{vj} = 125^\circ \text{C}$; 10 ms	280	A
i^2t	$T_{vj} = 25^\circ \text{C}$; 8,3...10 ms	510	A ² s
	$T_{vj} = 125^\circ \text{C}$; 8,3...10 ms	390	A ² s
V_T	$T_{vj} = 25^\circ \text{C}$, $I_T = 75 \text{ A}$	max. 2,45	V
$V_{T(TO)}$	$T_{vj} = 125^\circ \text{C}$	max. 1,1	V
r_T	$T_{vj} = 125^\circ \text{C}$	max. 20	m Ω
I_{DD}, I_{RD}	$T_{vj} = 125^\circ \text{C}$, $V_{RD} = V_{RRM}$	max. 8	mA
t_{gd}	$T_{vj} = 25^\circ \text{C}$, $I_G = 1 \text{ A}$; $di_G/dt = 1 \text{ A}/\mu\text{s}$	1	μs
t_{gr}	$V_D = 0,67 * V_{DRM}$	1	μs
$(dv/dt)_{cr}$	$T_{vj} = 125^\circ \text{C}$	1000	V/ μs
$(di/dt)_{cr}$	$T_{vj} = 125^\circ \text{C}$; $f = 50...60 \text{ Hz}$	50	A/ μs
t_q	$T_{vj} = 125^\circ \text{C}$; typ.	80	μs
I_H	$T_{vj} = 25^\circ \text{C}$; typ. / max.	80 / 150	mA
I_L	$T_{vj} = 25^\circ \text{C}$; $R_G = 33 \Omega$; typ. / max.	150 / 300	mA
V_{GT}	$T_{vj} = 25^\circ \text{C}$; d.c.	min. 2	V
I_{GT}	$T_{vj} = 25^\circ \text{C}$; d.c.	min. 100	mA
V_{GD}	$T_{vj} = 125^\circ \text{C}$; d.c.	max. 0,25	V
I_{GD}	$T_{vj} = 125^\circ \text{C}$; d.c.	max. 3	mA
$R_{th(j-s)}$	cont. per thyristor	1,7	K/W
	sin 180° per thyristor	1,78	K/W
$R_{th(j-s)}$	cont. per W1C	0,85	K/W
	sin 180° per W1C	0,89	K/W
T_{vj}		-40 ... +125	$^\circ \text{C}$
T_{stg}		-40 ... +125	$^\circ \text{C}$
T_{solder}	terminals, 10s	260	$^\circ \text{C}$
V_{isol}	a. c. 50 Hz; r.m.s.; 1 s / 1 min.	3000 / 2500	V~
M_s	Mounting torque to heatsink	1,5	Nm
M_t			Nm
a			m/s ²
m		13	g
Case	SEMITOP® 1	T 1	

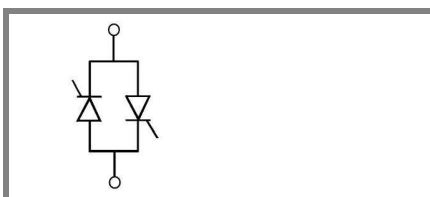

KQ

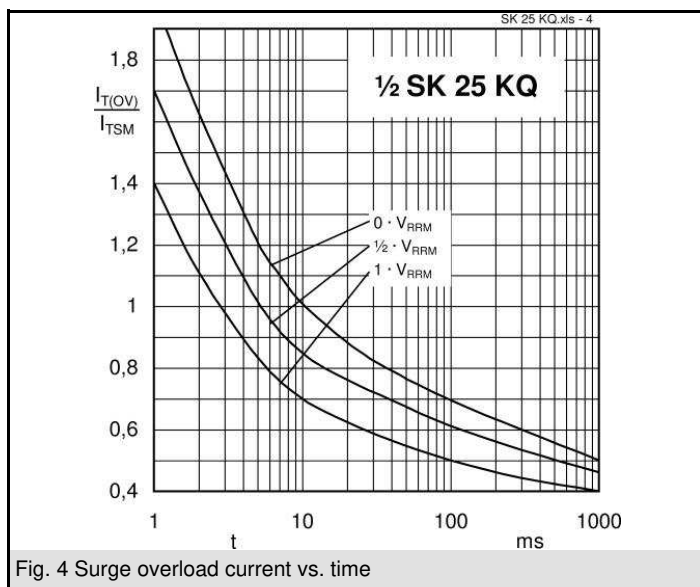
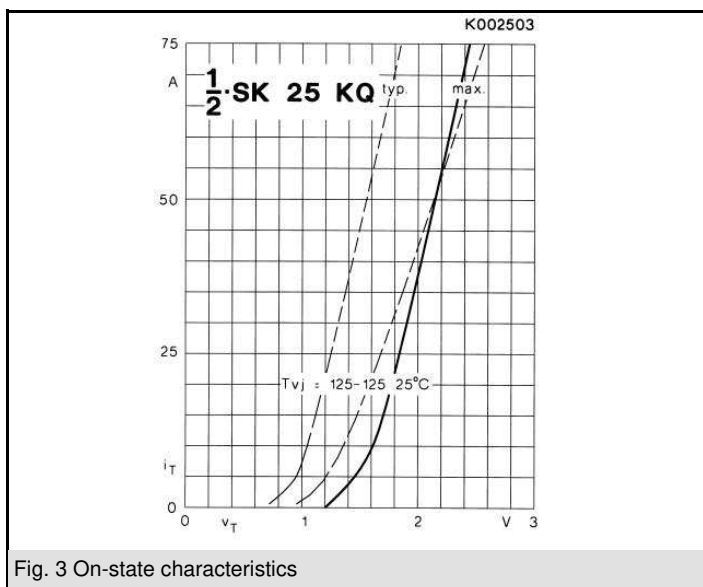
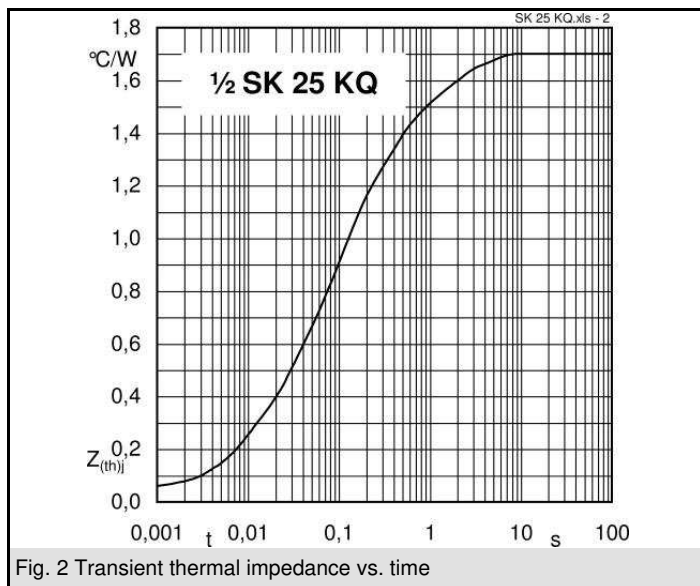
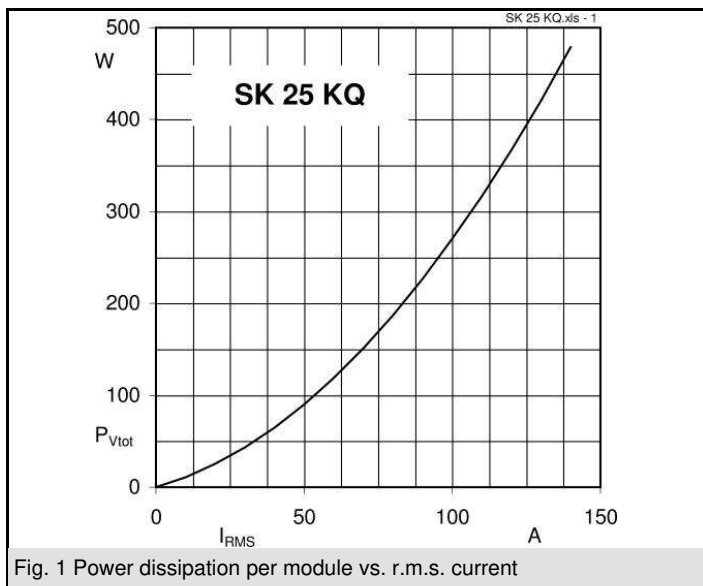

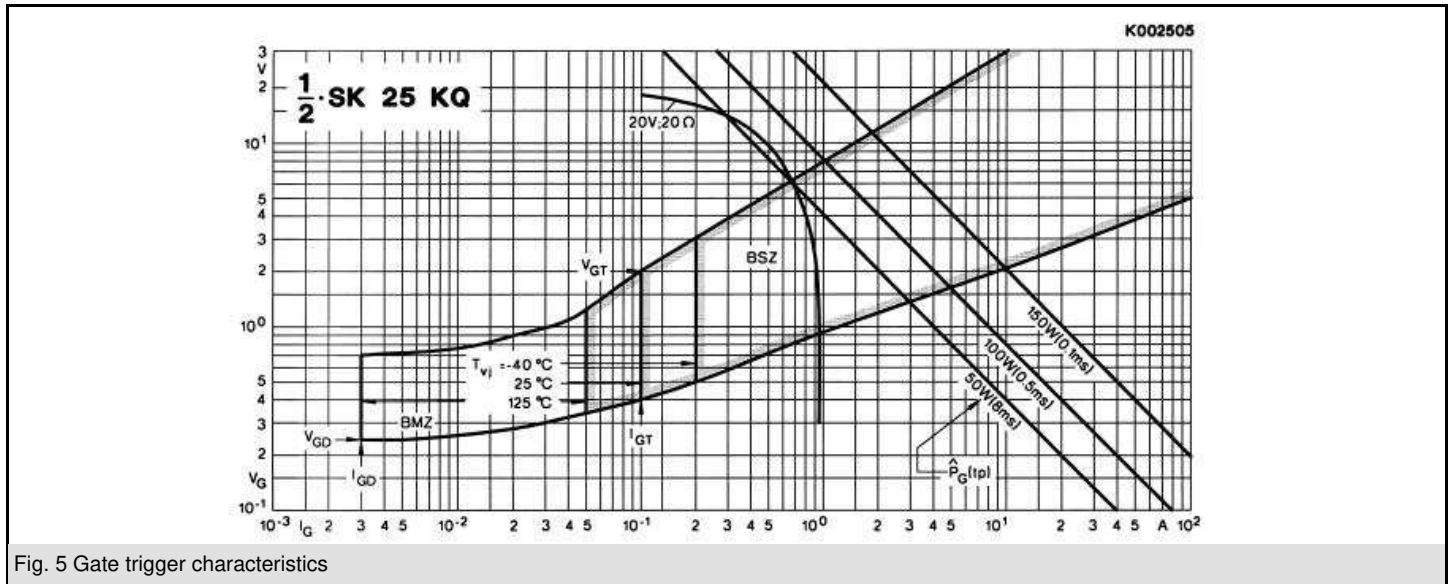
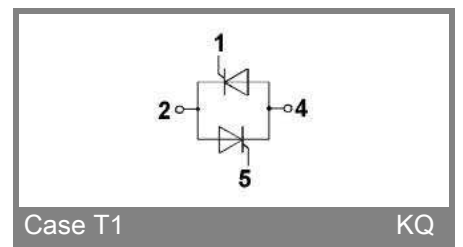
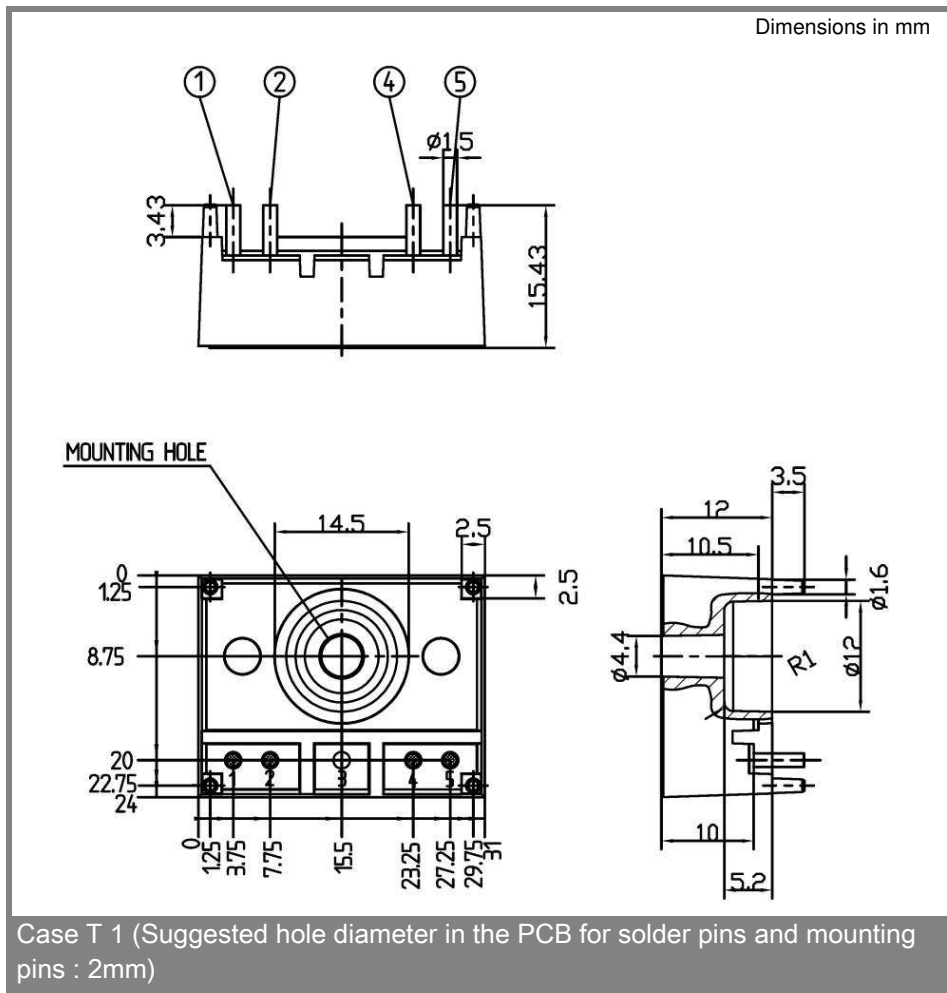

Fig. 5 Gate trigger characteristics



This technical information specifies semiconductor devices but promises no characteristics. No warranty or guarantee expressed or implied is made regarding delivery, performance or suitability.