

# SK 70 DH

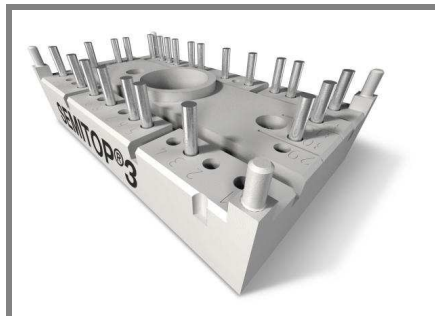

SEMITOP® 3

## Half Controlled Bridge Rectifier

### SK 70 DH

Preliminary Data

### Features

- Compact design
- One screw mounting
- Heat transfer and insulation through direct copper bonded aluminium oxide ceramic (DBC)
- Glass passivated thyristor chips
- Up to 1600V reverse voltage
- UL recognized, file no. E 63 532

### Typical Applications\*

- Soft starters
- Light control
- Temperature control
- Motor control

$V_{RSM}$ V	$V_{RRM}, V_{DRM}$ V	$I_D = 68 \text{ A (full conduction)}$ ( $T_s = 80 \text{ °C}$ )
900	800	SK 70 DH 08
1300	1200	SK 70 DH 12
1700	1600	SK 70 DH 16

Symbol	Conditions	Values	Units
$I_D$	$T_s = 80 \text{ °C}$	68	A
$I_{FSM} / I_{TSM}$	$T_{vj} = 25 \text{ °C}; 10 \text{ ms}$	370	A
	$T_{vj} = 125 \text{ °C}; 10 \text{ ms}$	270	A
$i^2t$	$T_{vj} = 25 \text{ °C}; 10 \text{ ms}$	685	A <sup>2</sup> s
	$T_{vj} = 125 \text{ °C}; 10 \text{ ms}$	365	A <sup>2</sup> s
$V_T$	$T_{vj} = 25 \text{ °C}; 75 \text{ A}$	max. 1,9	V
$V_{T(TO)}$	$T_{vj} = 125 \text{ °C};$	max. 1	V
$r_T$	$T_{vj} = 125 \text{ °C}$	max. 10	mΩ
$I_{DD}, I_{RD}$	$T_{vj} = 125 \text{ °C}; V_{DD} = V_{DRM}; V_{RD} = V_{RRM}$	max. 10	mA
$t_{gd}$	$T_{vj} = 25 \text{ °C}; I_G = 1 \text{ A}; di_G/dt = 1 \text{ A}/\mu\text{s}$	1	μs
$t_{gr}$	$V_D = 0,67 \cdot V_{DRM}$	2	μs
$(dv/dt)_{cr}$	$T_{vj} = 125 \text{ °C}$	max. 1000	V/μs
$(di/dt)_{cr}$	$T_{vj} = 125 \text{ °C}; f = 50 \dots 60 \text{ Hz}$	max. 50	A/μs
$t_q$	$T_{vj} = 125 \text{ °C}; \text{typ.}$	120	μs
$I_H$	$T_{vj} = 25 \text{ °C}; \text{typ. / max.}$	80 / 150	mA
$I_L$	$T_{vj} = 25 \text{ °C}; R_G = 33 \text{ } \Omega$	150 / 300	mA
$V_{GT}$	$T_{vj} = 25 \text{ °C}; \text{d.c.}$	min. 2	V
$I_{GT}$	$T_{vj} = 25 \text{ °C}; \text{d.c.}$	min. 100	mA
$V_{GD}$	$T_{vj} = 125 \text{ °C}; \text{d.c.}$	max. 0,25	V
$I_{GD}$	$T_{vj} = 125 \text{ °C}; \text{d.c.}$	max. 3	mA
$R_{th(j-s)}$	Per thyristor	1,2	K/W
	Per diode	1,7	K/W
$T_{solder}$	Terminals, 10s	260	°C
$T_{vj}$	Diodes	-40...+150	°C
$T_{vj}$			°C
$T_{stg}$		-40...+125	°C
$T_{vj}$	Thyristors	-40...+125	°C
$V_{isol}$	a. c. 50 Hz; r.m.s.; 1 s / 1 min.	3000 ( 2500 )	V
$M_s$	Mounting torque to heatsink	2,5	Nm
m	weight	30	g
Case	SEMITOP® 3	T 40	

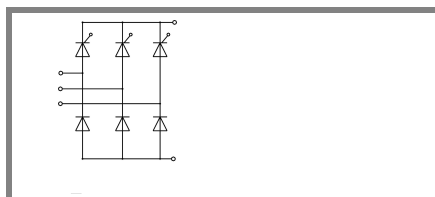

DH

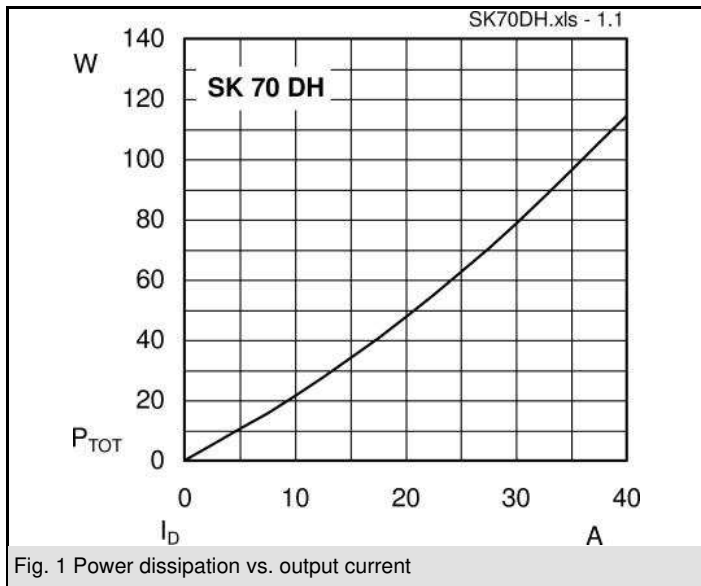

Fig. 1 Power dissipation vs. output current

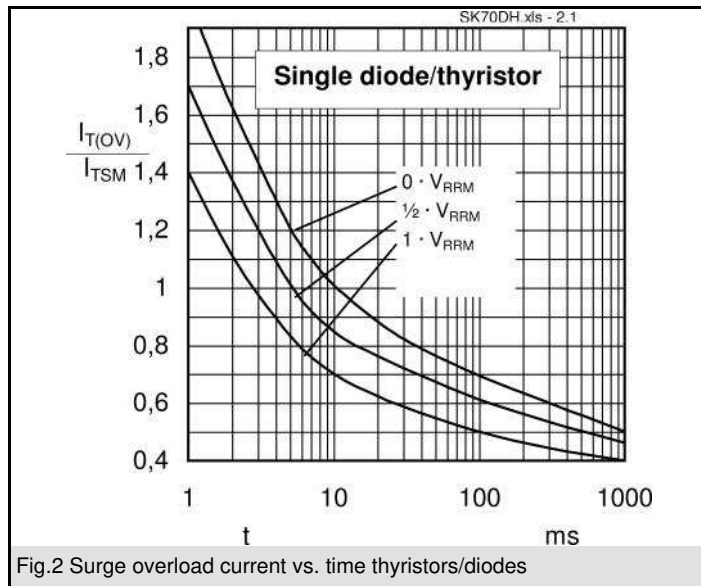

Fig. 2 Surge overload current vs. time thyristors/diodes

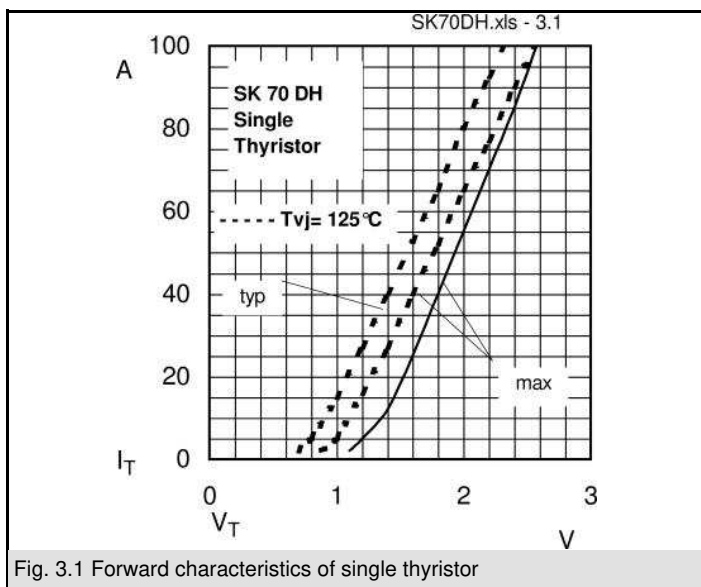

Fig. 3.1 Forward characteristics of single thyristor

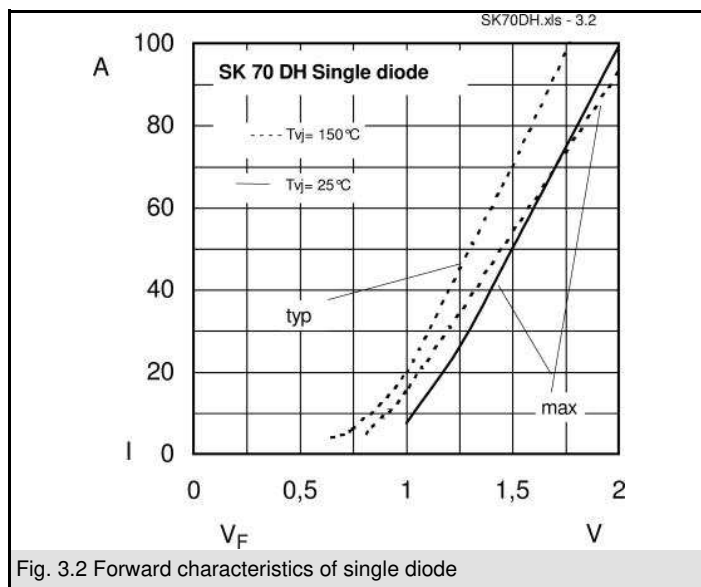

Fig. 3.2 Forward characteristics of single diode

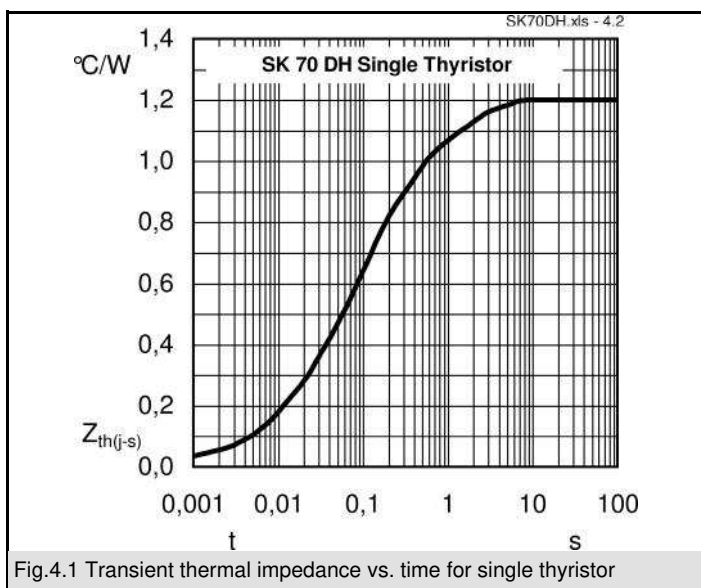

Fig. 4.1 Transient thermal impedance vs. time for single thyristor

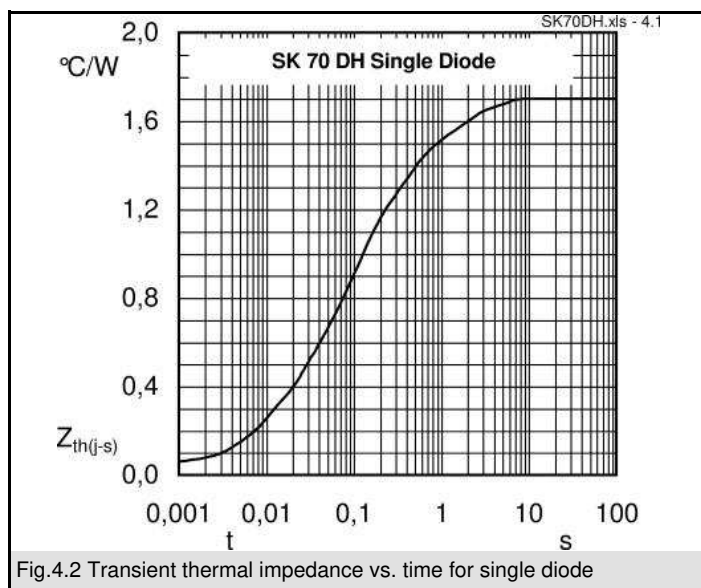

Fig. 4.2 Transient thermal impedance vs. time for single diode

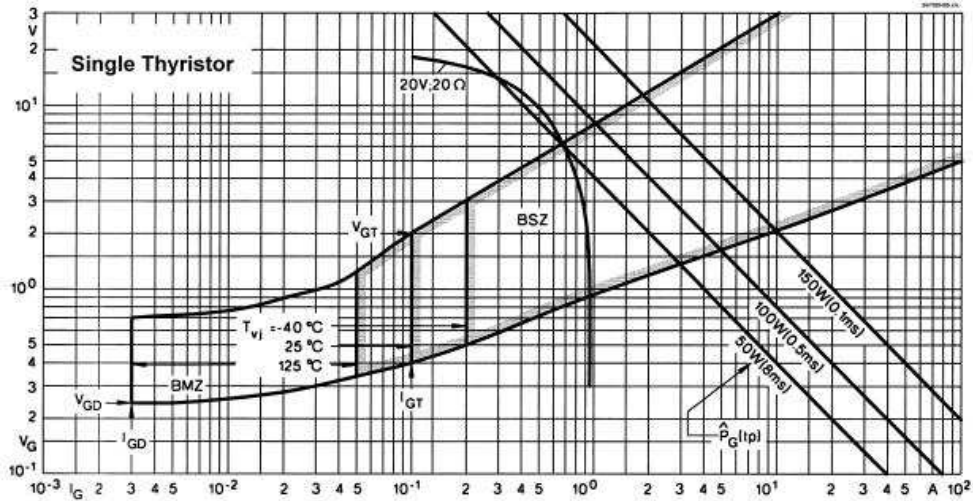
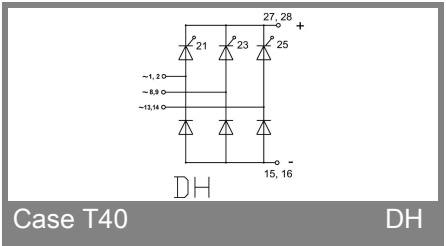
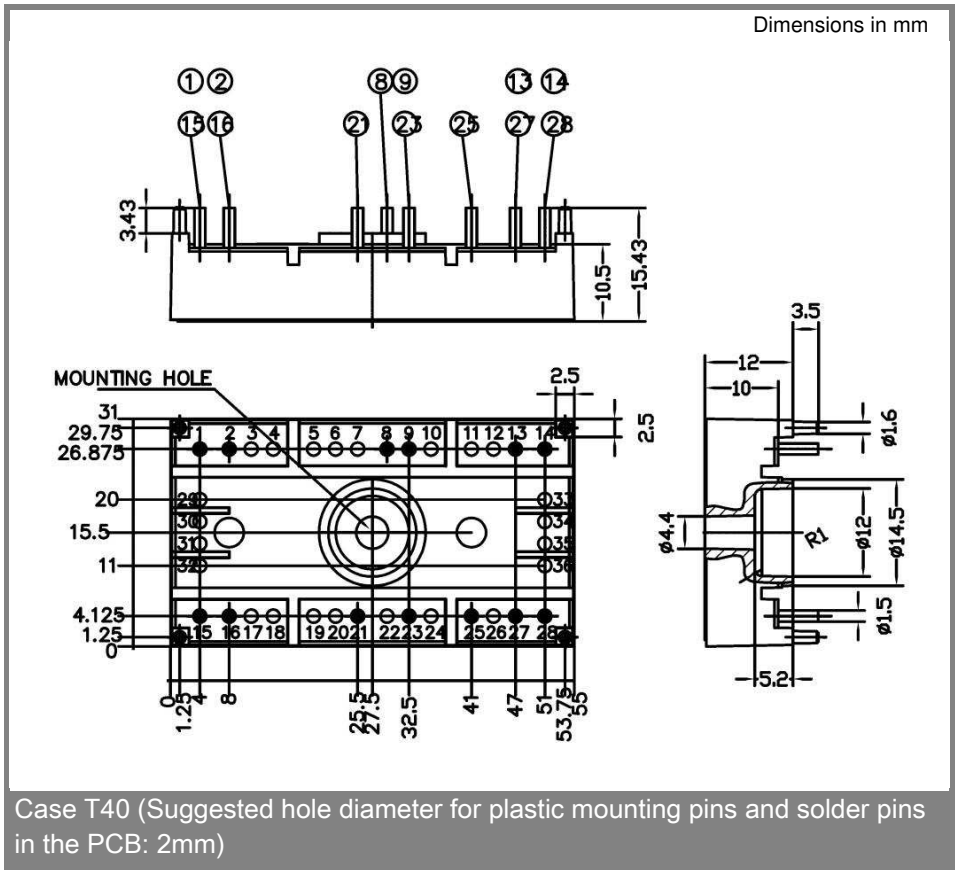

Fig. 5 Gate trigger characteristics



\* The specifications of our components may not be considered as an assurance of component characteristics. Components have to be tested for the respective application. Adjustments may be necessary. The use of SEMIKRON products in life support appliances and systems is subject to prior specification and written approval by SEMIKRON. We therefore strongly recommend prior consultation of our personal.