

# SK 95 D

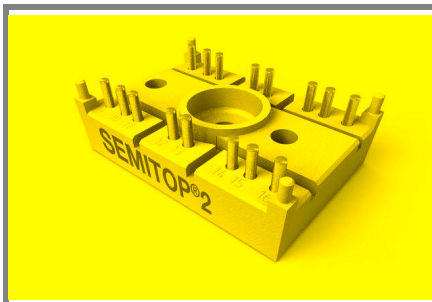

**SEMITOP® 2**

## Bridge Rectifier

### SK 95 D

Preliminary Data

### Features

- Compact design
- One screw mounting
- Heat transfer and insulation through direct copper bonded aluminium oxide ceramic (DCB)
- Up to 1600V reverse voltage
- High surge currents
- Glass passivated diodes chips
- UL recognized, file no. E 63 532

### Typical Applications\*

- Input rectifier for power supplies
- Rectifier

$V_{RSM}$ V	$V_{RRM}, V_{DRM}$ V	$I_D = 95$ A (full conduction) ( $T_s = 80$ °C)
800	800	SK 95 D 08
1200	1200	SK 95 D 12
1600	1600	SK 95 D 16

Symbol	Conditions	Values	Units
$I_D$	$T_s = 80$ °C	95	A
$I_{FSM}$	$T_{vj} = 25$ °C; 10 ms $T_{vj} = 150$ °C; 10 ms	700 560	A A
$i^2t$	$T_{vj} = 25$ °C; 8,3...10 ms $T_{vj} = 150$ °C; 8,3...10 ms	2450 1370	A <sup>2</sup> s A <sup>2</sup> s
$V_F$	$T_{vj} = 25$ °C; $I_F = 35$ A	max. 1,2	V
$V_{(TO)}$	$T_{vj} = 150$ °C	max. 0,8	V
$r_T$	$T_{vj} = 150$ °C	max. 11	mΩ
$I_{RD}$	$T_{vj} = 150$ °C; $V_{DD} = V_{DRM}$ ; $V_{RD} = V_{RRM}$	max. 4	mA mA
$R_{th(f-s)}$	per diode per module	1,2 0,2	K/W K/W
$T_{solder}$	terminals, 10s	260	°C
$T_{vj}$		-40...+150	°C
$T_{stg}$		-40...+125	°C
$V_{isol}$	a. c. 50 Hz; r.m.s.; 1 s / 1 min.	3000 ( 2500 )	V
$M_s$	mounting torque to heatsink	2	Nm
$M_t$			
m	approx. weight	19	g
Case	SEMITOP® 2	T 7	

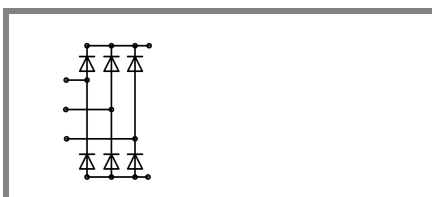

D

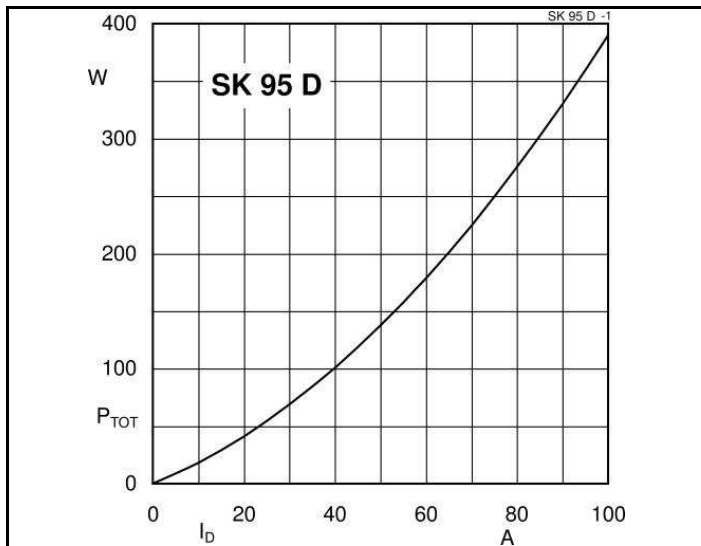

Fig. 1 Power dissipation vs. Output current

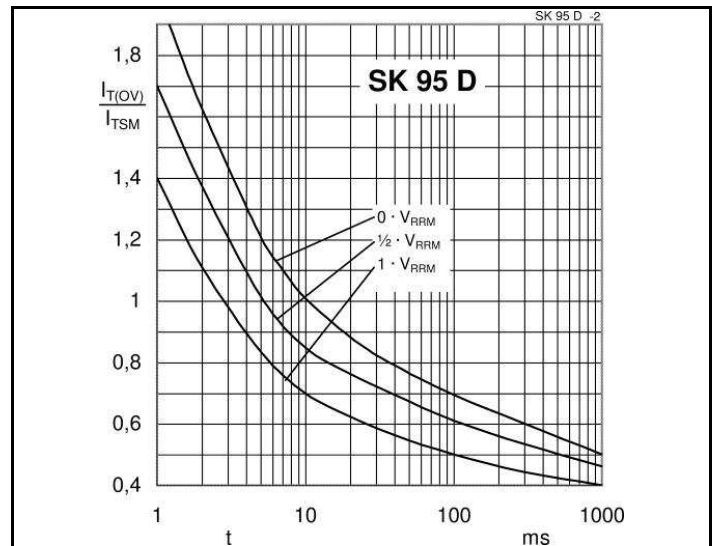

Fig. 2 Surge overload current vs. time

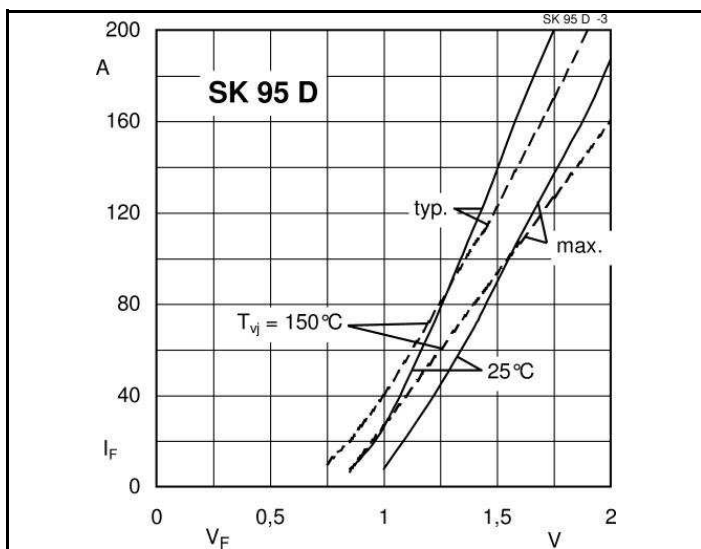

Fig. 3 Forward characteristics of single diode

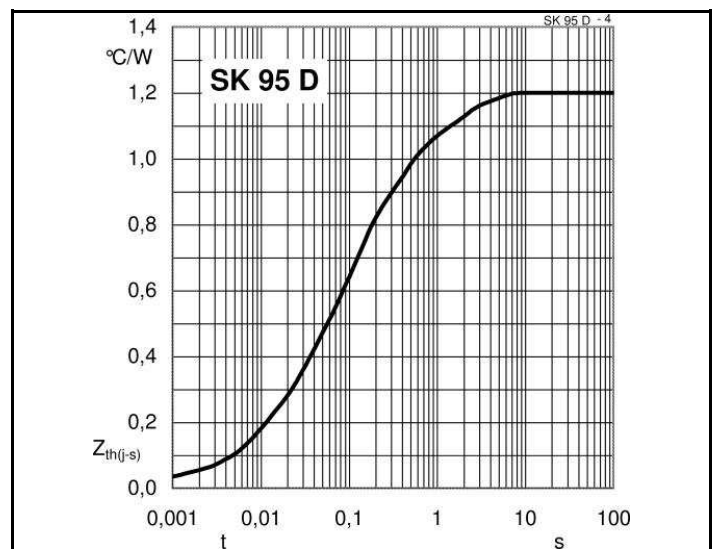
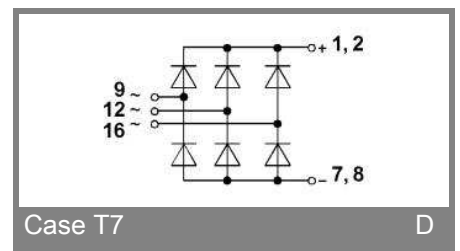
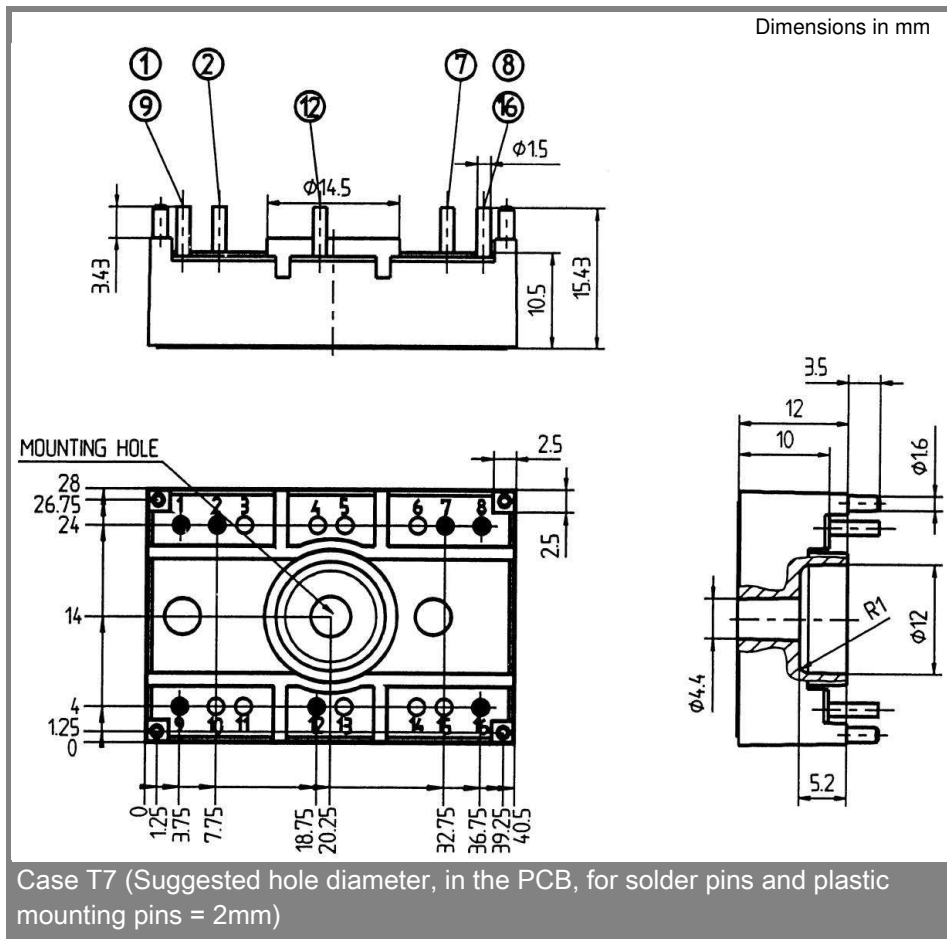

Fig. 4 Thermal transient impedance vs. time



\* The specifications of our components may not be considered as an assurance of component characteristics. Components have to be tested for the respective application. Adjustments may be necessary. The use of SEMIKRON products in life support appliances and systems is subject to prior specification and written approval by SEMIKRON. We therefore strongly recommend prior consultation of our personal.